

**PH-17015**  
**PH-17016**

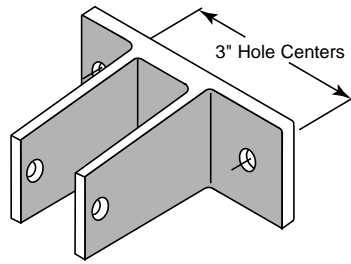

**PH-17015** (For 1" panels)  
**PH-17016** (For 1-1/4" panels)

## Two-Ear Wall Bracket

**Contents:** 1 bracket.

**Description:** Chrome plated, diecast bracket for attaching partition panel to wall.

You may wish to stock these related parts: **PH-17009, PH-17039, PH-17061, PH-17064.**

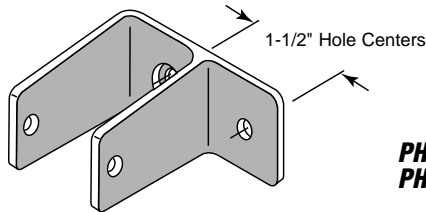

**PH-17017**  
**PH-17018**

**PH-17017** (For 1" panels)  
**PH-17018** (For 1-1/4" panels)

## One-Ear Wall Bracket

**Contents:** 1 bracket.

**Description:** Chrome plated, diecast bracket for attaching partition panel to wall.

You may wish to stock these related parts: **PH-17008, PH-17038, PH-17061, PH-17063.**

**PH-17019**  
**PH-17020**

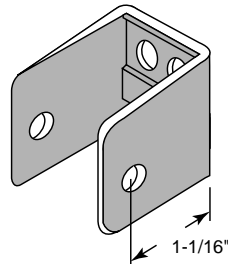

**PH-17019** (For 1" panels)  
**PH-17020** (For 1-1/4" panels)

## "U" Bracket

**Contents:** 1 bracket.

**Description:** Chrome plated, diecast bracket for attaching partition panel to wall.

You may wish to stock these related parts: **PH-17015, PH-17040, PH-17059, PH-17061.**

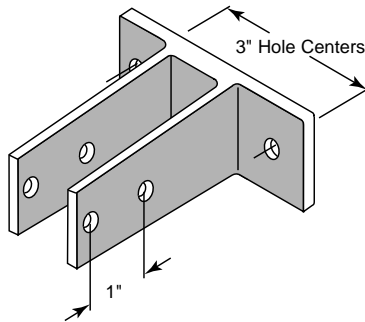

**PH-17021**

**PH-17021** (For 1" panels)

## Urinal Screen Wall Bracket

**Contents:** 1 bracket.

**Description:** Chrome plated, diecast bracket for attaching urinal screen partition panels to wall.

You may wish to stock these related parts: **PH-17015, PH-17040, PH-17059, PH-17061.**

**PH-17022**

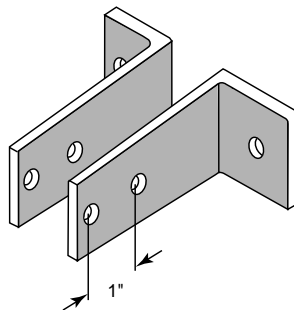

**PH-17022** (All size panels)

## Urinal Screen Wall Bracket

**Contents:** 1 bracket.

**Description:** Chrome plated, diecast bracket for attaching urinal screen partition panels to wall.

You may wish to stock these related parts: **PH-17015, PH-17040, PH-17059, PH-17061.**

## PH-17023 (For 1" panels)

### Headrail Bracket

**Contents:** 1 headrail bracket.

**Description:** Chrome plated, diecast bracket for attaching headrail support to wall.

You may wish to stock these related parts: PH-17016, PH-17029, PH-17057, PH-17061.

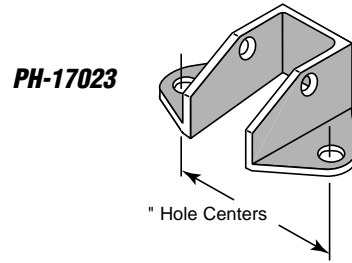

## PH-17024

### Bottom Hinge Bracket

**Contents:** 1 hinge bracket.

**Description:** Chrome plated, diecast bottom hinge bracket for bottom of door; use with steel panels; fits 1-1/4" pilaster.

You may wish to stock these related parts: PH-17013, PH-17044, PH-17057, PH-17061.

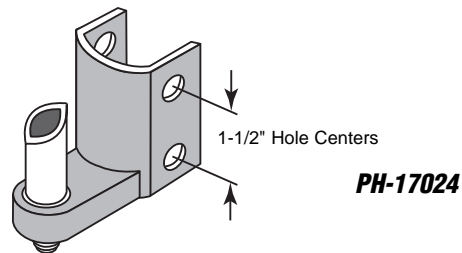

## PH-17025

### Top Hinge Bracket

**Contents:** 1 hinge bracket.

**Description:** Chrome plated, diecast top hinge bracket for top of door; use with steel panels; fits 1-1/4" pilaster.

You may wish to stock these related parts: PH-17014, PH-17037, PH-17055, PH-17061.

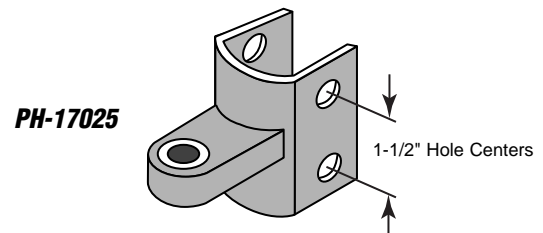

## PH-17026

### Bottom Hinge Bracket

**Contents:** 1 hinge bracket.

**Description:** Chrome plated, diecast bottom hinge bracket for bottom of door; use with plastic laminate or marble panels; fits 1-1/4" pilaster.

You may wish to stock these related parts: PH-17017, PH-17031, PH-17055, PH-17061.

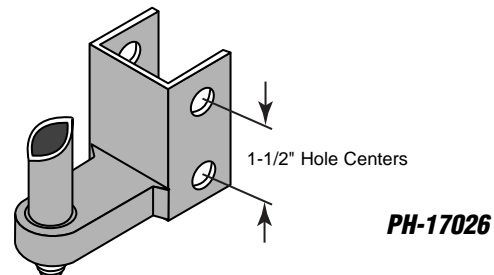

## PH-17027

### Top Hinge Bracket

**Contents:** 1 hinge bracket.

**Description:** Chrome plated, diecast top hinge bracket for top of door; use with plastic laminate or marble panels; fits 1-1/4" pilaster.

You may wish to stock these related parts: PH-17015, PH-17040, PH-17059, PH-17061.

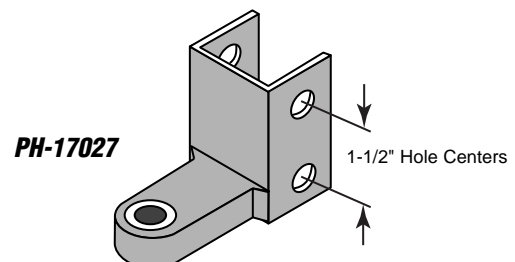

**PH-17008**

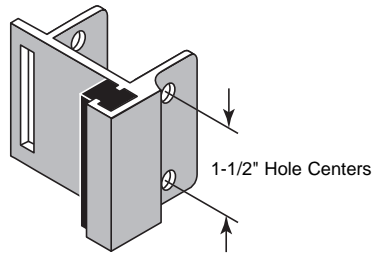

**PH-17008** (For 1-1/4" pilaster)

## Strike/Keeper

**Contents:** 1 strike/keeper.

**Description:** Chrome plated, diecast keeper; surface slide latch for supporting and latching of **inswing** doors; use with plastic laminate or marble panels.

You may wish to stock these related parts: **PH-17010, PH-17039, PH-17061, PH-17064.**

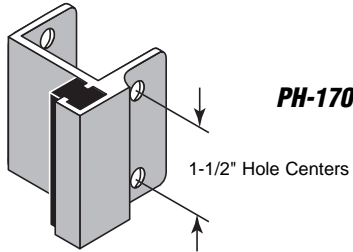

**PH-17009**

**PH-17009** (For 1-1/4" pilaster)

## Strike/Keeper

**Contents:** 1 strike/keeper.

**Description:** Chrome plated, diecast keeper; surface slide latch for supporting and latching of **outswing** doors; use with plastic laminate or marble panels.

You may wish to stock these related parts: **PH-17016, PH-17042, PH-17057, PH-17061.**

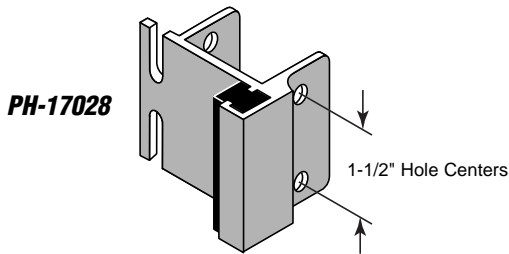

**PH-17028**

**PH-17028** (For 1-1/4" pilaster)

## Strike/Keeper

**Contents:** 1 strike/keeper.

**Description:** Chrome plated, diecast keeper; use with plastic laminate or marble panels; for throw latch on **outswing** door.

You may wish to stock these related parts: **PH-17016, PH-17042, PH-17057, PH-17061.**

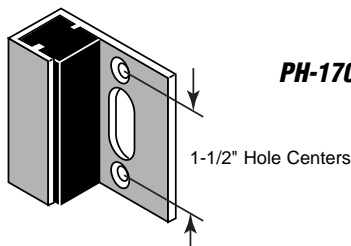

**PH-17029**

**PH-17029**

## Flat Strike

**Contents:** 1 flat strike.

**Description:** Chrome plated, diecast keeper; use with plastic laminate or marble panels; fits any size pilaster; for concealed latch on **inswing** door.

You may wish to stock these related parts: **PH-17014, PH-17037, PH-17055, PH-17061.**

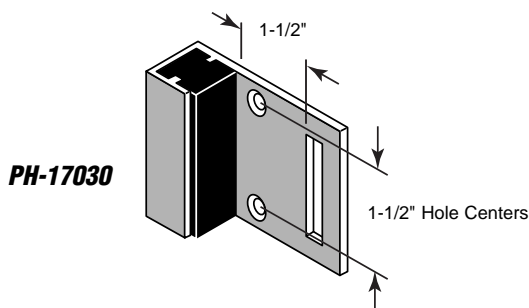

**PH-17030**

**PH-17030**

## Flat Strike

**Contents:** 1 flat strike.

**Description:** Chrome plated, diecast keeper; use with plastic laminate or marble panels; fits any size pilaster; for slide latch on **inswing** door.

You may wish to stock these related parts: **PH-17017, PH-17031, PH-17055, PH-17061.**

## PH-17031

### Flat Strike

**Contents:** 1 flat strike.

**Description:** Chrome plated, diecast strike; use with plastic laminate or marble panels; fits any size pilaster; for slide latch on outswing door.

You may wish to stock these related parts: PH-17015, PH-17040, PH-17059, PH-17061.

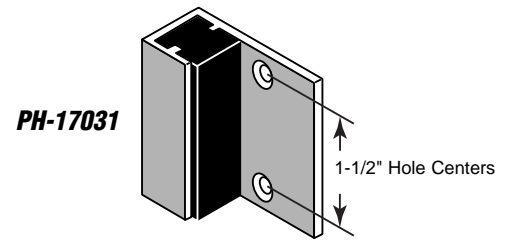

## PH-17032

### Keeper

**Contents:** 1 keeper.

**Description:** Chrome plated, diecast keeper for slide latch; fits any size pilaster.

You may wish to stock these related parts: PH-17014, PH-17037, PH-17055, PH-17061.

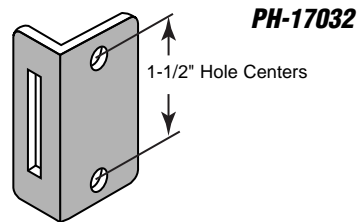

## PH-17033

### Strike

**Contents:** 1 strike.

**Description:** Chrome plated, diecast strike for slide latch or throw latch; fits any size pilaster.

You may wish to stock these related parts: PH-17009, PH-17036, PH-17048, PH-17061.

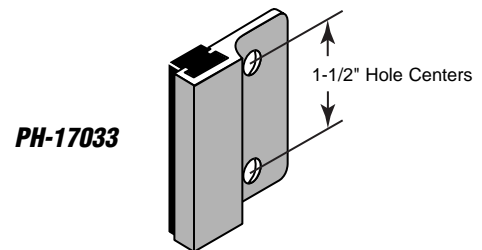

## PH-17034

### Keeper

**Contents:** 1 keeper.

**Description:** Chrome plated, diecast keeper for throw latch; fits any size pilaster.

You may wish to stock these related parts: PH-17044, PH-17046, PH-17061, PH-17063.

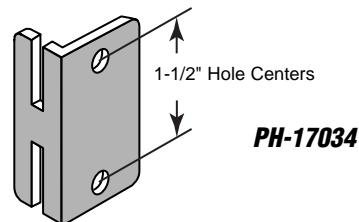

## PH-17035 (For 1-1/4" pilaster)

### Strike/Keeper

**Contents:** 1 strike/keeper.

**Description:** Chrome plated, diecast keeper; use with steel panels; for slide latch on inswing door.

You may wish to stock these related parts: PH-17039, PH-17040, PH-17048, PH-17061.

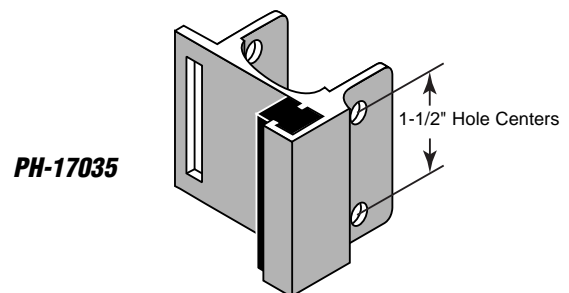

**PH-17036**

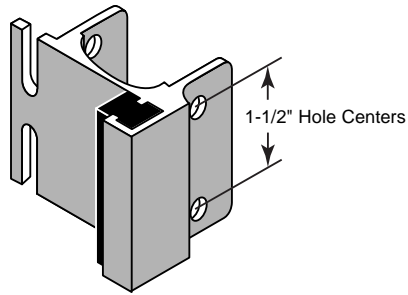

**PH-17036** (For 1-1/4" pilaster)

## Strike/Keeper

**Contents:** 1 strike/keeper.

**Description:** Chrome plated, diecast strike/keeper; use with steel panels; for throw latch on **inswing** door.

You may wish to stock these related parts: **PH-17044, PH-17048, PH-17061, PH-17064.**

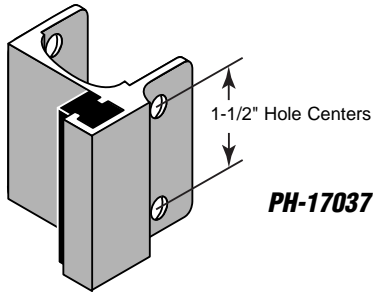

**PH-17037** (For 1-1/4" pilaster)

## Strike/Keeper

**Contents:** 1 strike/keeper.

**Description:** Chrome plated, diecast strike/keeper; use with steel panels; for throw latch on **outswing** door.

You may wish to stock these related parts: **PH-17039, PH-17040, PH-17046, PH-17061.**

**PH-17038**

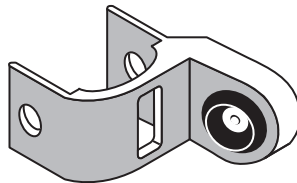

**PH-17038** (For 1-1/4" pilaster)

## Strike/Keeper

**Contents:** 1 strike/keeper.

**Description:** Chrome plated, diecast strike/keeper; use with steel panels; for round bar concealed latch.

You may wish to stock these related parts: **PH-17041, PH-17042, PH-17043, PH-17061.**

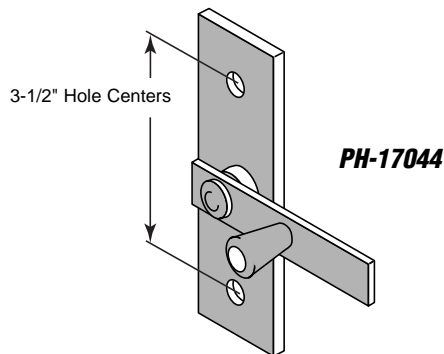

**PH-17044**

## Throw Latch

**Contents:** 1 slide latch.

**Description:** Chrome plated, brass throw latch; use with any door thickness.

You may wish to stock these related parts: **PH-17028, PH-17034, PH-17036, PH-17061.**

**PH-17039**

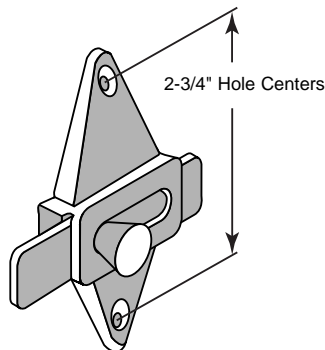

**PH-17039**

## Slide Latch

**Contents:** 1 slide latch.

**Description:** Chrome plated, diecast slide latch; use with any door thickness.

You may wish to stock these related parts: **PH-17030, PH-17032, PH-17035, PH-17061.**

## PH-17040

### Slide Latch

**Contents:** 1 slide latch.

**Description:** Chrome plated, diecast slide latch; use with any thickness door.

You may wish to stock these related parts: PH-17030, PH-17032, PH-17035, PH-17061.

PH-17040

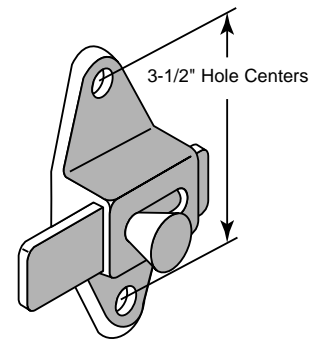

## PH-17041

### Emergency Entry Knob

**Contents:** 1 emergency entry knob.

**Description:** Chrome plated, diecast entry knob; use with PH-17045 concealed door lock.

You may wish to stock these related parts: PH-17042, PH-17045.

1-9/16" Dia. 1-1/4" Dia.

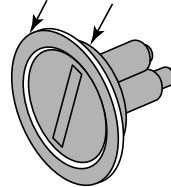

PH-17041

## PH-17042

### Interior Locking Knob

**Contents:** 1 interior locking knob.

**Description:** Chrome plated, diecast locking knob; use with PH-17045 concealed door lock.

You may wish to stock these related parts: PH-17042, PH-17045.

1-9/16" Dia.



PH-17042

## PH-17043

### Concealed Lock

**Contents:** 1 concealed lock.

**Description:** Chrome plated, diecast concealed lock with straight bar; use with 1" thick laminate doors.

You may wish to stock these related parts: PH-17029, PH-17038, PH-17046, PH-17061.

1-9/16" Dia. 1-1/4" Dia.

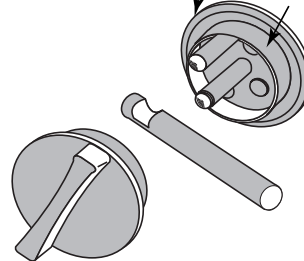

PH-17043

## PH-17062

### Concealed Lock

**Contents:** 1 concealed lock.

**Description:** Chrome plated, diecast concealed lock with flat bar; use with 1" thick steel doors.

You may wish to stock these related parts: PH-17039, PH-17040, PH-17043, PH-17044.

1-11/16" Dia. 1-3/16" Dia.

PH-17062

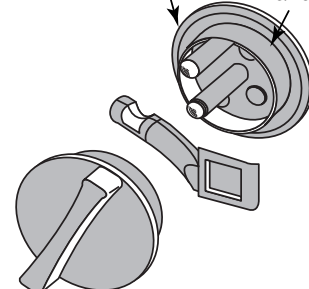

**PH-17045**

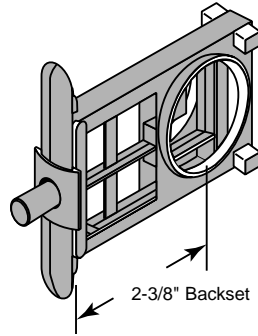

## PH-17045

### Concealed Door Lock

**Contents:** 1 concealed door lock.

**Description:** Zamak diecasting; for use on 1" thick doors; may be used with PH-17041 and PH-17042.

You may wish to stock these related parts: PH-17041, PH-17042.

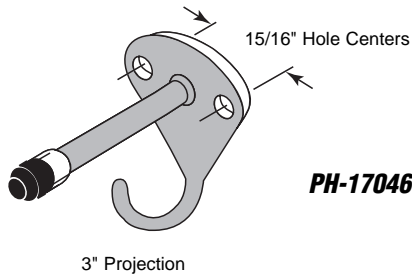

**PH-17046**

## PH-17046

### Bumper Hook

**Contents:** 1 bumper hook.

**Description:** Chrome plated, diecast bumper hook; rubber tipped; for general purpose use.

You may wish to stock these related parts: PH-17039, PH-17040, PH-17044, PH-17061.

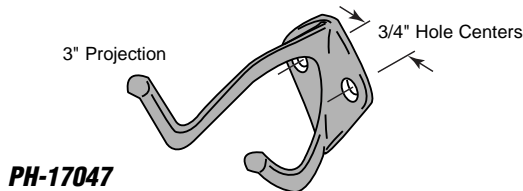

**PH-17047**

## PH-17047

### Coat Hook

**Contents:** 1 coat hook.

**Description:** Chrome plated, diecast coat hook; two prongs; for general purpose use.

You may wish to stock these related parts: PH-17039, PH-17040, PH-17044, PH-17061.

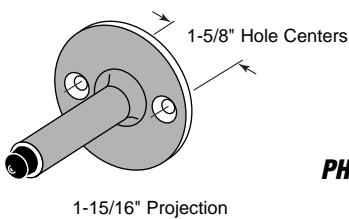

**PH-17048**

## PH-17048

### Door Stop

**Contents:** 1 door stop.

**Description:** Chrome plated, diecast door stop; rubber tipped; for general purpose use.

You may wish to stock these related parts: PH-17039, PH-17040, PH-17044, PH-17061.

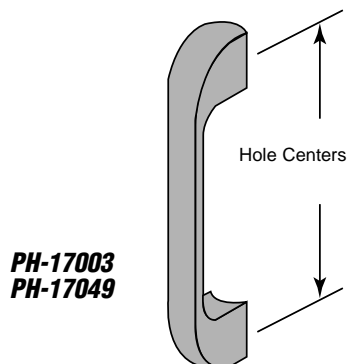

**PH-17003**  
**PH-17049**

**PH-17003** (3-1/2" hole centers)

**PH-17049** (3-1/2" and 4" hole centers)

## Door Pull

**Contents:** 1 door pull.

**Description:** Chrome plated, diecast door pull; 4-#10-24 tapped holes; for general purpose use.

You may wish to stock these related parts: PH-17039, PH-17040, PH-17044, PH-17061.

# Restroom Partition Hardware

**PH-17050** (1/2" Chrome plated brass)

**PH-17051** (5/8" Chrome plated steel)

**PH-17052** (5/8" Chrome plated brass)

## "One-Way" Barrel Nut

**Contents:** 10 barrel nuts.

**Description:** Chrome plated, brass and steel barrel nuts; #10-24 threads; use with shoulder bolts for various part assemblies.

**PH-17050  
PH-17051  
PH-17052**

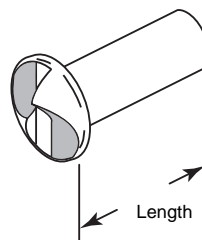

**PH-17053** (1/2" Chrome plated brass)

**PH-17054** (15/16" Chrome plated brass)

**PH-17055** (1-3/16" Chrome plated steel)

## "One-Way" Shoulder Screw

**Contents:** 10 shoulder screws.

**Description:** Chrome plated, brass and steel shoulder screws; #10-24 threads; use with barrel nuts for various part assemblies.

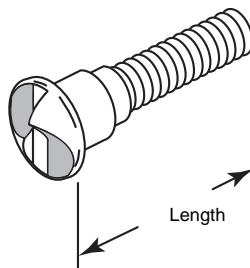

**PH-17053  
PH-17054  
PH-17055**

**PH-17056** (3/4" Chrome plated steel)

**PH-17057** (1-3/8" Chrome plated steel)

## "One-Way" Machine Screw

**Contents:** 10 machine screws.

**Description:** Chrome plated, steel machine screws; #8-32 threads; use on general purpose applications.

**PH-17056  
PH-17057**

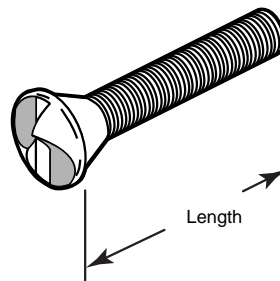

**PH-17058** (No. 8 x 3/4")

**PH-17059** (No. 10 x 3/4")

## "One-Way" Sheet Metal Screw

**Contents:** 10 sheet metal screws.

**Description:** Chrome plated, steel metal screws; for use on various part assemblies as well as general purpose applications.

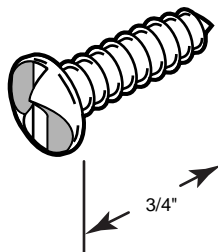

**PH-17058  
PH-17059**

**PH-17061**

## "One-Way" Screw Removal Tool

**Contents:** 1 tool.

**Description:** Specially designed to remove "one-way" fasteners, either #8 or #10 sizes.

You may wish to stock these related parts: PH-17050, PH-17051, PH-17052, PH-17053, PH-17054, PH-17055, PH-17056, PH-17057, PH-17058, PH-17059, PH-17060, PH-17061.

**PH-17061**

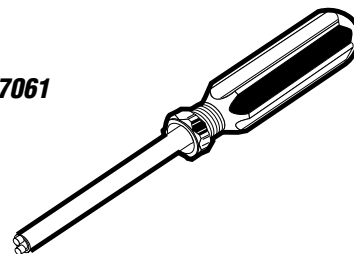



**PH-17108**

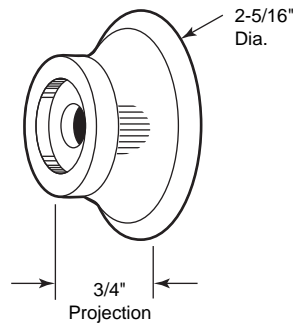

**PH-17108** (Clear)

## Door Bumper

**Contents:** 2 door stops; 2 no. 6 x 1-1/4" Phillips pan head sheet metal screws; 2 no. 6 x 1" plastic anchors.

**Description:** Clear soft vinyl; protects against marred walls; absorbs impact of door knob at contact point with wall; easily detached from wall by removing screw. Clear plastic construction is unassuming and allows paint colors or wall paper design to show through.

You may wish to stock these related parts: **PH-17039, PH-17040, PH-17044, PH-17061.**

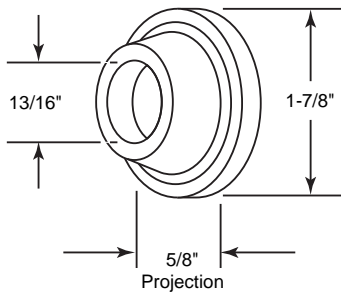

**PH-17063**  
**PH-17064**

**PH-17063** (White)

**PH-17064** (Gray)

## Door Bumper

**Contents:** 2 bumpers.

**Description:** Solid rubber; concave center; self-adhering; absorbs impact of door knob at contact point with wall.

You may wish to stock these related parts: **PH-17039, PH-17040, PH-17044, PH-17061.**

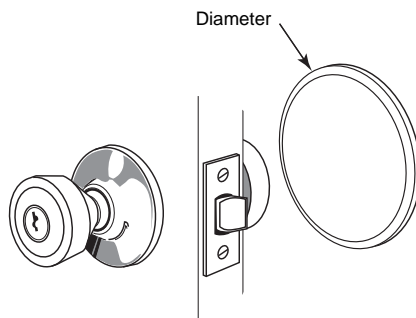

**PH-17109**  
**PH-17110**

**PH-17109** (3-1/4" Diameter)

**PH-17110** (5" Diameter)

## Wall Protector (Ivory)

**Contents:** 1 protector.

**Description:** Rigid vinyl; self adhesive; protects interior walls from impact damage by shielding contact point of wall and door knob; repairs damaged walls.

You may wish to stock these related parts: **PH-17039, PH-17040, PH-17044, PH-17061.**

**PH-17107**

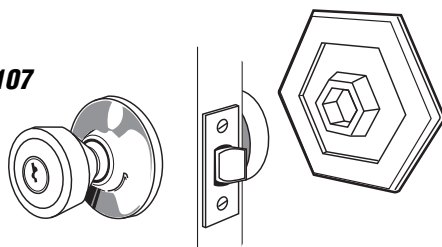

**PH-17107** (White)

## Wall Protector (5" hexagon)

**Contents:** 1 shield

**Description:** Flexible vinyl; self-adhesive; paintable; protects interior walls from impact damage by shielding contact point of wall and door knob; repairs damaged walls.

You may wish to stock these related parts: **PH-17039, PH-17040, PH-17044, PH-17061.**