

## G-3018

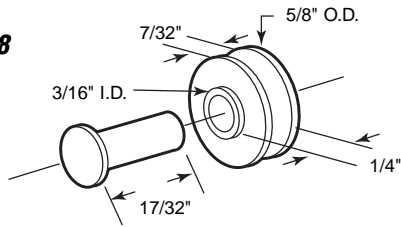

## G-3018

### Roller

**Contents:** 4 rollers; 4 axle pins.

**Description:** 7/32" x 5/8" center grooved nylon roller; aluminum rivet type axle pins; fits on *Air Control*.

You may wish to stock these related parts: F-2504, F-2541.

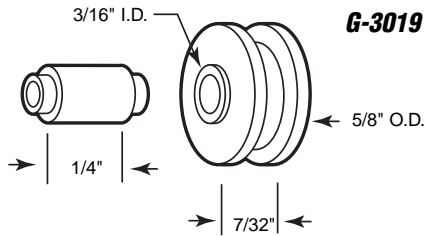

## G-3019

## G-3019

### Roller

**Contents:** 4 rollers; 4 axle pins.

**Description:** 7/32" x 5/8" center-grooved nylon roller; aluminum axle pins; repair part for G-3021; fits on *Trimview*.

You may wish to stock these related parts: G-3020.

## G-3020

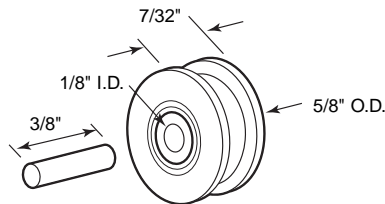

## G-3020

### Roller

**Contents:** 4 rollers; 4 axle pins.

**Description:** 7/32" x 5/8" center-grooved nylon ball bearing roller; aluminum axle pins; repair part for G-3021; fits on *Trimview*.

You may wish to stock these related parts: G-3019.

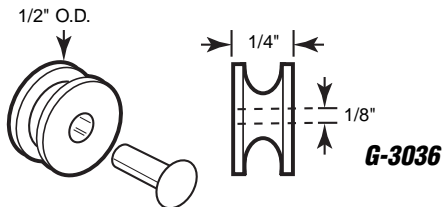

## G-3036

## G-3036

### Roller

**Contents:** 4 rollers; 4 axle pins.

**Description:** 1/4" x 1/2" nylon roller; deep center groove; accepts a 1/8" rivet style axle; used by several sliding window manufacturers.

## G-3040

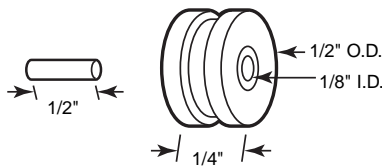

## G-3040

### Roller

**Contents:** 4 rollers; 4 axle pins.

**Description:** 1/4" x 1/2" nylon roller with center groove; aluminum axle pins; used by several sliding window manufacturers.

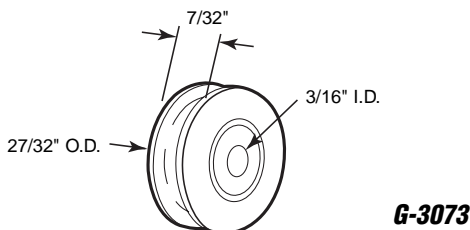

## G-3073

## G-3073

### Roller

**Contents:** 2 rollers.

**Description:** 7/32" x 27/32" diameter steel ball bearing roller with center groove; used on sliding aluminum windows.

You may wish to stock these related parts: G-3014.

# Sliding Window Rollers & Guides

## G-3090

### Roller

**Contents:** 2 rollers.

**Description:** 5/16" x 3/4" nylon roller; 1/8" narrow groove; fits on *Ralley* windows.

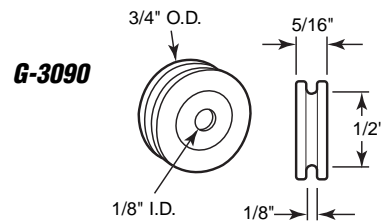

## G-3015 (Steel)

## G-3098 (Stainless steel)

### Roller

**Contents:** 4 rollers; 4 axle pins.

**Description:** 1/8" x 7/16" flat steel roller; nylon axle pins; fits on *Premiere*.

You may wish to stock these related parts: **G-3060**, **G-3088**, **G-3136**.

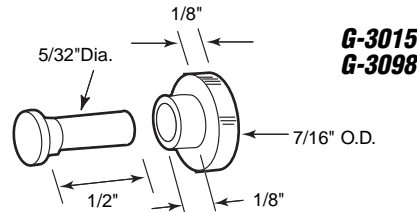

## G-3016

### Roller

**Contents:** 4 rollers; 4 axle pins.

**Description:** 5/32" x 7/16" flat nylon roller; nylon axle pins; fits on *HiLite*.

You may wish to stock these related parts: **F-2500**, **F-2502**, **F-2525**.

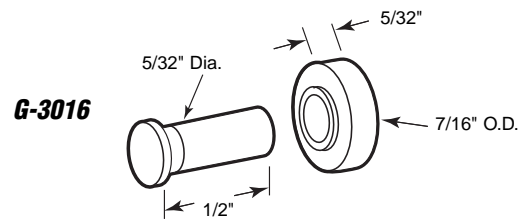

## G-3017

### Roller

**Contents:** 8 rollers; 8 axle pins.

**Description:** 9/32" x 3/8" flat nylon roller; aluminum rivet style axle pins; repair part for **G-3005**.

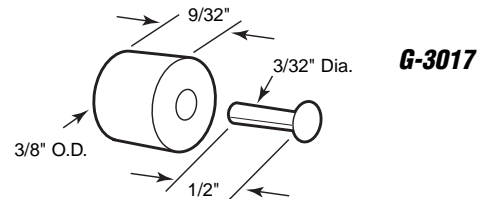

## G-3031

### Roller

**Contents:** 4 rollers; 4 axle pins.

**Description:** 5/16" x 7/32" flat nylon roller; nylon axle pins; fits on *Radco*.

You may wish to stock these related parts: **G-3028**, **G-3029**, **G-3030**, **G-3062**, **G-3153**.

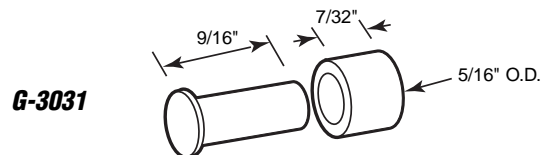

## G-3060

### Roller

**Contents:** 4 rollers; 4 axle pins.

**Description:** 3/16" x 1/2" flat steel roller; nylon axle pins; fits on *Premiere* and *Keller* windows.

You may wish to stock these related parts: **F-2541**, **F-2542**, **G-3088**.

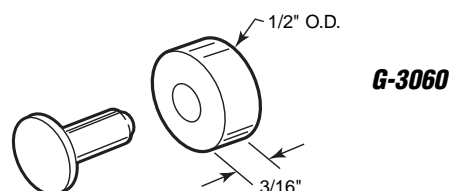

## G-3082

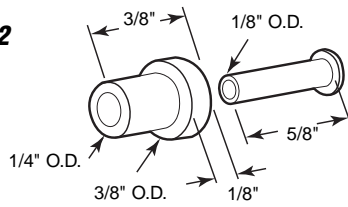

## G-3082

### Roller

**Contents:** 2 rollers; 2 axles.

**Description:** 1/8" x 3/8" steel roller; rivet style steel axles; fits on *Fullview* windows.

You may wish to stock these related parts: **F-2553, G-3009, G-3010, G-3011, G-3026.**

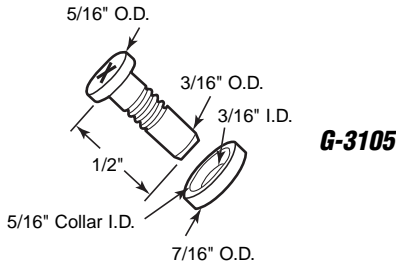

## G-3105

### Roller and Axle Screw

**Contents:** 2 axle screws; 2 roller bushings.

**Description:** Steel axle screw with nylon roller; fits on *Rolleze* windows.

You may wish to stock these related parts: **F-2553, F-2608, G-3065.**

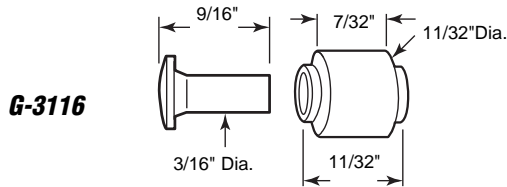

## G-3116

### Roller

**Contents:** 2 rollers; 2 axles.

**Description:** Solid brass rollers with nylon axles; fits on *Viking Series M70* windows.

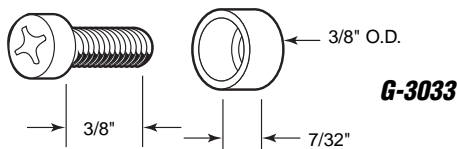

## G-3033

### Roller

**Contents:** 4 rollers; 4 no. 8-32 x 3/8" Phillips pan head machine screws.

**Description:** Nylon roller assembly; fits on *C & P Window*.

You may wish to stock these related parts: **F-2520, G-3032.**

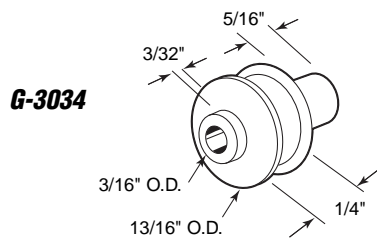

## G-3034

### Roller

**Contents:** 4 rollers.

**Description:** 1/4" x 13/16" nylon roller; extended hub; fits on *Cupples* windows.

You may wish to stock these related parts: **F-2528.**

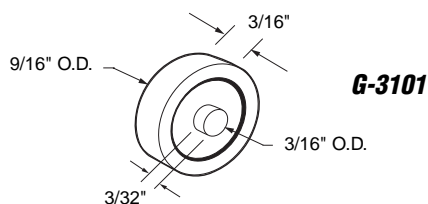

## G-3101

### Roller

**Contents:** 2 rollers.

**Description:** 3/16" x 9/16" steel ball bearing roller; replacement roller for *G-3072*; fits on *Thermo Glide, Bee Cee* and others.

You may wish to stock these related parts: **G-3047, G-3056.**

Call for Availability

Call for Availability

## G-3092

### Roller Assembly

**Contents:** 2 roller assemblies.

**Description:** Stamped steel housing with 7/16" diameter center groove nylon roller; used on sliding storm windows and showcase windows.

You may wish to stock these related parts: **G-3035, G-3087, G-3093, G-3094, G-3095.**

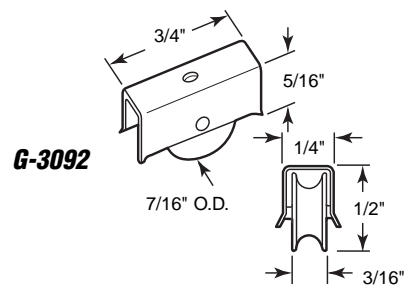

## G-3093

### Roller Assembly

**Contents:** 2 roller assemblies.

**Description:** Stamped steel housing with 3/8" diameter convex nylon roller; used on sliding storm windows and showcase windows.

You may wish to stock these related parts: **G-3035, G-3087, G-3092, G-3094, G-3095.**

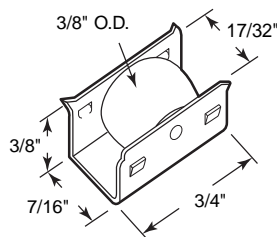

**G-3093**

## G-3094 (Nylon roller)

## G-3095 (Steel roller)

### Roller Assembly

**Contents:** 2 roller assemblies.

**Description:** Stamped steel housing with 9/16" diameter roller; used on sliding storm windows and showcase windows.

You may wish to stock these related parts: **G-3035, G-3041, G-3087, G-3092, G-3093.**

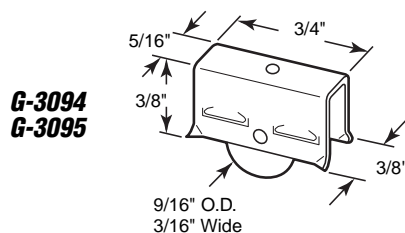

**G-3094  
G-3095**

## G-3123

### Roller Assembly

**Contents:** 2 roller assemblies.

**Description:** Stamped steel housing with 5/16" diameter flat edge nylon roller; used on sliding storm windows and showcase windows.

You may wish to stock these related parts: **G-3035, G-3087, G-3092, G-3094, G-3095.**

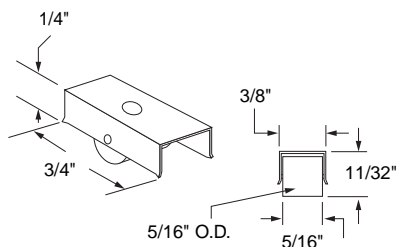

**G-3123**

## G-3128

### Roller Assembly

**Contents:** 2 roller assemblies.

**Description:** Stamped steel housing; flat edge nylon roller; used on sliding windows and showcase doors.

You may wish to stock these related parts: **G-3035, G-3087, G-3092, G-3093, G-3095.**

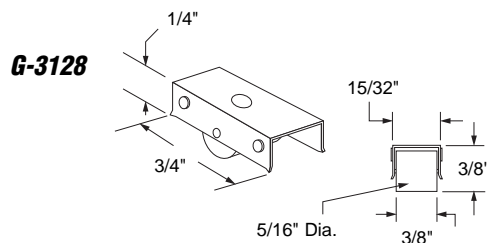

**G-3128**

## G-3125

### Roller Assembly

**Contents:** 2 roller assemblies.

**Description:** Stamped steel housing with 9/16" diameter flat edge nylon roller; used on sliding storm windows and showcase windows.

You may wish to stock these related parts: **G-3035, G-3087, G-3093, G-3094, G-3095.**

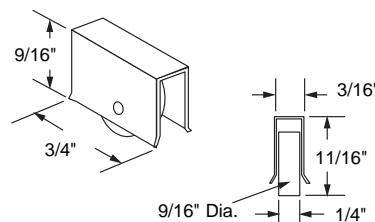

**G-3125**

**G-3035**  
**G-3087**

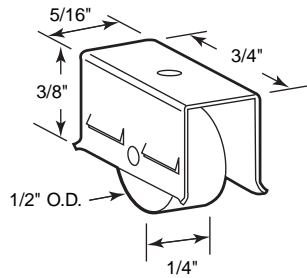
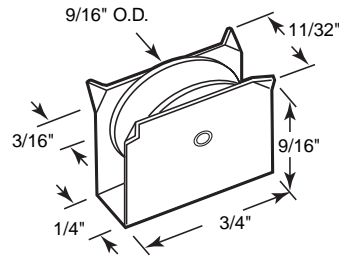

**G-3041**

**G-3042**

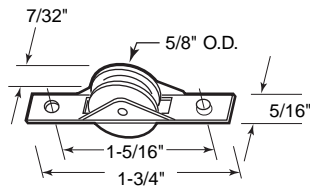
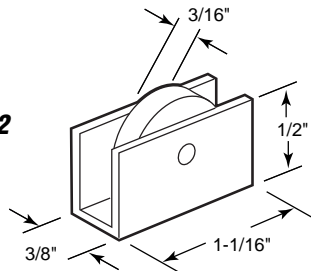

**G-3039**

**G-3053**

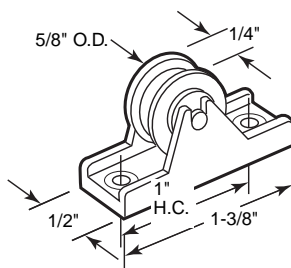
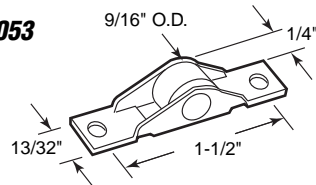

**G-3051**

**G-3035** (Steel roller)  
**G-3087** (Nylon roller)

## Roller Assembly

**Contents:** 2 roller assemblies.

**Description:** Stamped steel housing with 9/16" diameter concave roller; used on sliding windows and showcase windows.

You may wish to stock these related parts: **F-2549**, **F-2550**, **F-2551**.

## G-3041

### Roller Assembly

**Contents:** 2 roller assemblies.

**Description:** Stamped steel housing; 1/4" x 1/2" convex nylon roller.

## G-3042

### Roller Assembly

**Contents:** 2 roller assemblies.

**Description:** Extruded aluminum housing; flat edge steel roller.

Call for  
Availability

## G-3039

### Roller Assembly

**Contents:** 2 roller assemblies.

**Description:** Stamped steel housing; concave nylon roller; fits on *Fullview* windows.

You may wish to stock these related parts: **F-2553**.

## G-3053

### Roller Assembly

**Contents:** 2 roller assemblies.

**Description:** Steel housing with 9/16" diameter flat edge nylon roller; used on sliding storm and showcase windows.

## G-3051

### Roller Assembly

**Contents:** 2 roller assemblies.

**Description:** Nylon housing; center-grooved steel ball bearing roller; used by several window manufacturers.

# Sliding Window Rollers & Guides

**G-3052** (5/8" diameter x 3/16" thick)

**G-3152** (3/4" diameter x 1/4" thick)

## Roller Assembly

**Contents:** 2 roller assemblies.

**Description:** Nylon housing; flat edge steel roller; used by several window manufacturers.

**G-3052**  
**G-3152**

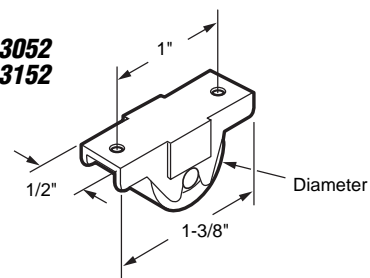

## G-3000

### Roller Assembly

**Contents:** 2 roller assemblies.

**Description:** Aluminum bracket with 1/8" x 1/2" flat edge nylon roller; fits on *International "King-Queen"* series, also fits on *Academy* and *A-1 Aluminum*.

You may wish to stock these related parts: **F-2517**, **F-2521**, **F-2522**.

**G-3000**

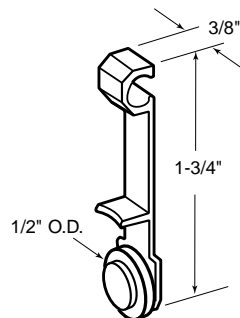

## G-3135

### Roller Assembly

**Contents:** 2 roller assemblies.

**Description:** Aluminum bracket with 1/8" x 1/2" flat edge nylon roller; fits on *Century-Elco* windows.

You may wish to stock these related parts: **G-3118**, **G-3122**.

**G-3135**

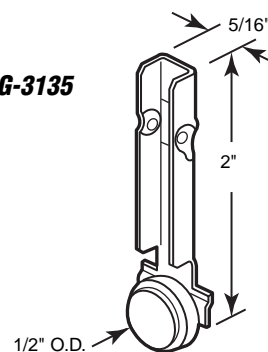

## G-3001 (Nylon roller)

### Roller Assembly

**Contents:** 2 rollers assemblies.

**Description:** Aluminum bracket with 1/8" x 5/8" flat edge roller; fits on *International* windows.

You may wish to stock these related parts: **F-2517**, **F-2521**, **F-2522**.

**G-3001**

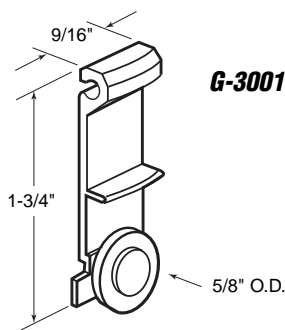

## G-3102

### Roller Assembly

**Contents:** 2 roller assemblies.

**Description:** Extruded aluminum bracket; 1/8" x 1/2" flat edge steel roller; fits on *International* windows.

You may wish to stock these related parts: **F-2517**, **F-2521**, **F-2522**.

**G-3102**

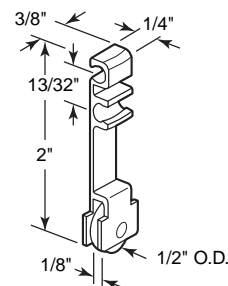

**G-3124**

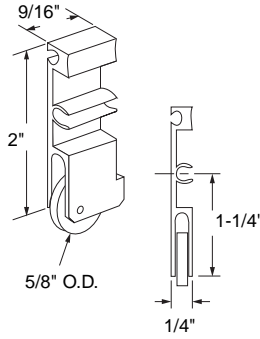

**G-3137**

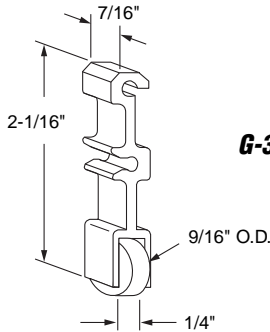

**G-3138**

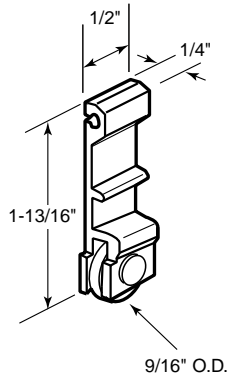

**G-3003  
G-3076**

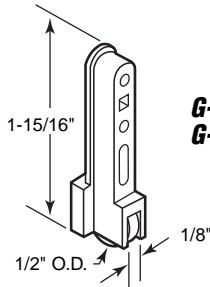

**G-3004**

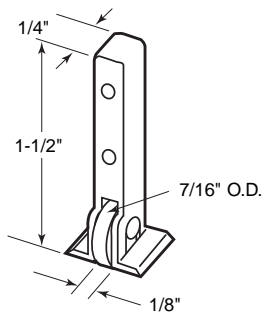

**G-3002  
G-3075**

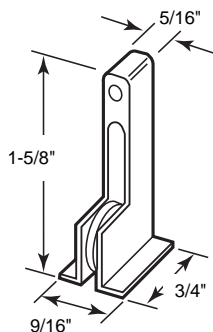

**G-3124**

## Roller Assembly

**Contents:** 2 roller assemblies.

**Description:** Extruded aluminum bracket with 1/8" x 5/8" steel roller; fits on *International* windows and others.

**G-3137**

## Roller Assembly

**Contents:** 2 roller assemblies.

**Description:** Extruded aluminum bracket; 1/4" x 9/16" diameter heavy duty steel roller; fits on *International* insulated glass windows.

**G-3138**

## Roller Assembly

**Contents:** 2 roller assemblies.

**Description:** Extruded aluminum bracket; 1/8" x 9/16" solid brass roller; fits on *Guaranteed Products* and others.

You may wish to stock these related parts: **F-2512, F-2597, F-2647.**

**G-3003** (Nylon roller - 4 per card)

**G-3076** (Steel roller - 2 per card)

## Roller Assembly

**Contents:** Roller assemblies.

**Description:** Nylon housing; 1/8" x 1/2" flat roller; top rollers adjust "up" to provide anti-lift protection; bottom rollers adjust "up and down" for alignment; fits on *Hilite 200 Series* windows.

You may wish to stock these related parts: **F-2500, F-2502, F-2543.**

**G-3004**

## Roller Assembly

**Contents:** 4 roller assemblies.

**Description:** Nylon housing; 1/8" x 7/16" flat edge nylon roller; fits on *Guaranteed Products*.

You may wish to stock these related parts: **F-2512, F-2597, F-2647.**

**G-3002** (Nylon roller)

**G-3075** (Steel roller)

## Roller Assembly

**Contents:** 2 rollers assemblies.

**Description:** Nylon housing, with 1/8" x 1/2" flat edge roller; fits on *HiLite* convertible windows.

You may wish to stock these related parts: **F-2500, F-2501, F-2543.**

# Sliding Window Rollers & Guides

## G-3083

### Roller Assembly

**Contents:** 2 roller assemblies.

**Description:** Nylon housing; 1/8" x 3/8" nylon roller; fits on *Guaranteed* windows.

You may wish to stock these related parts: F-2512, F-2597, F-2647.

**G-3083**

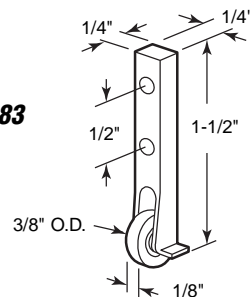

## G-3084 (1/16" guide leg)

## G-3085 (1/8" guide leg)

### Roller Assembly

**Contents:** 2 roller assemblies.

**Description:** Gray nylon housing; 1/8" x 1/2" nylon roller; fits on *A-1 Aluminum, Horizon, Sun Air, International, Patio Concepts* and others.

You may wish to stock these related parts: F-2512, F-2517, F-2521.

**G-3084  
G-3085**

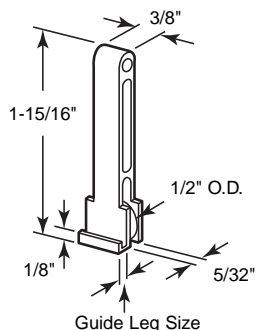

## G-3088

### Roller Assembly

**Contents:** 2 roller assemblies.

**Description:** Black nylon housing; nylon roller; 1/16" guide leg; fits on *Premiere* and others.

You may wish to stock these related parts: G-3084, G-3085.

**G-3088**

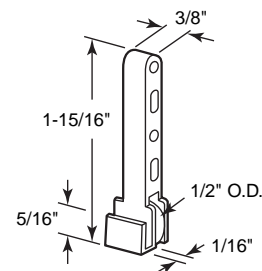

## G-3032

### Roller Assembly

**Contents:** 4 roller assemblies.

**Description:** Nylon adjustable housing; 1/4" x 7/16" nylon roller; fits on *C & P Window*.

You may wish to stock these related parts: F-2520, G-3033.

Call for  
Availability

**G-3032**

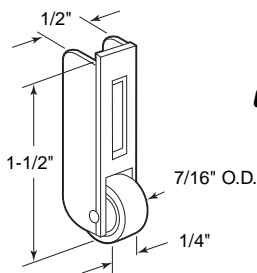

## G-3077 (Nylon roller)

## G-3156 (Brass roller)

### Roller Assembly

**Contents:** 2 roller assemblies.

**Description:** Stamped aluminum housing; 1/8" x 1/2" roller; fits on *International* windows.

You may wish to stock these related parts: F-2517, F-2521, F-2522, G-3000, G-3001, G-3102.

**G-3077  
G-3156**

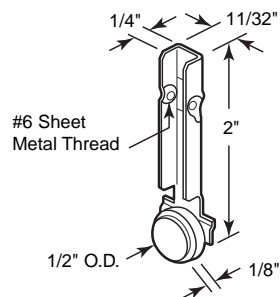

## G-3005

### Roller Assembly

**Contents:** 4 roller assemblies.

**Description:** Adjustable bracket with 9/32" x 3/8" flat edge nylon roller; used by several window manufacturers.

You may wish to stock these related parts: G-3017.

**G-3005**

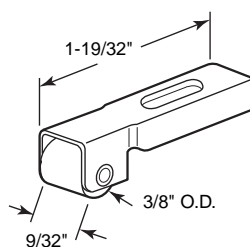



Call for  
Availability

**G-3067**  
**G-3068**

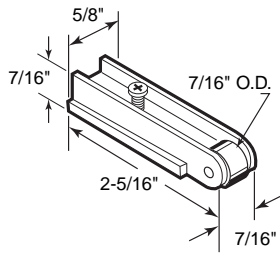

**G-3067** (Aluminum finish)  
**G-3068** (Bronze finish)

## Roller Assembly

**Contents:** 2 roller assemblies.

**Description:** Extruded aluminum housing; 7/16" diameter nylon roller; fits on *Bell* windows.

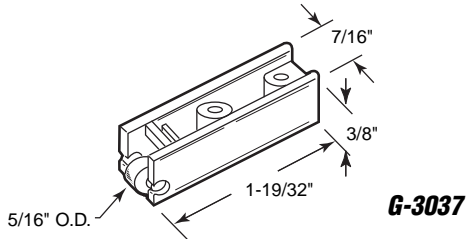

**G-3037**

## G-3037

### Roller Assembly

**Contents:** 4 roller assemblies.

**Description:** Nylon housing with flat edge nylon roller; fits on *Air Flow* patio windows.

**G-3038**

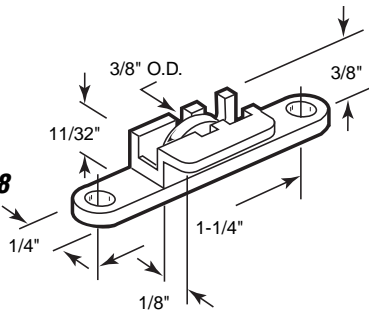

**G-3038** (Steel roller)

### Roller Assembly

**Contents:** 4 roller assemblies

**Description:** Nylon housing with flat edge steel roller; fits on *Tomrays Tyco 66* windows.

You may wish to stock these related parts: **F-2543**, **F-2544**.

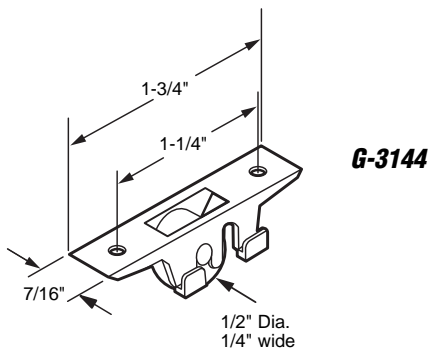

**G-3144**

**G-3144** (Nylon roller)

### Roller Assembly

**Contents:** 2 roller assemblies

**Description:** White nylon housing; solid brass axles; fits on *Guaranteed Products* and others.

You may wish to stock these related parts: **F-2512**, **F-2597**, **F-2647**.

**G-3011**

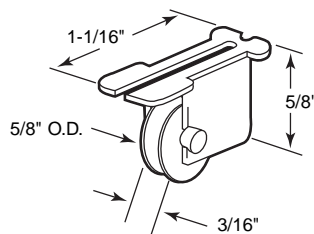

## G-3011

### Roller Assembly

**Contents:** 2 roller assemblies.

**Description:** Nylon housing; 3/16" x 5/8" steel roller; fits on *Fullview*.

You may wish to stock these related parts: **F-2553**.

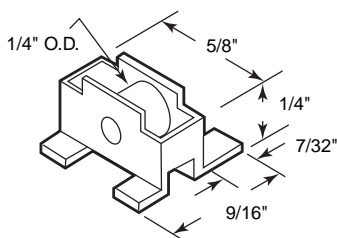

**G-3030**  
**G-3153**

**G-3030** (Nylon roller - 4 per card)  
**G-3153** (Brass roller - 2 per card)

### Roller Assembly

**Contents:** Roller assemblies.

**Description:** Offset guide leg; flat edge roller; nylon housing; fits on *Radco* and *Glass Emporium*.

You may wish to stock these related parts: **G-3028**, **G-3029**, **G-3031**, **G-3062**.

# Sliding Window Rollers & Guides

## G-3050

### Roller Assembly

**Contents:** 4 roller assemblies.

**Description:** Nylon housing; flat edge nylon ball bearing roller.

## G-3106

### Roller Assembly

**Contents:** 2 roller assemblies.

**Description:** Nylon housing with 7/16" diameter steel, center-grooved roller; fits on *Krestmark*.

## G-3147

### Roller Assembly

**Contents:** 2 roller assemblies.

**Description:** White nylon housing; nylon concave roller; fits on *H-R Windows* and others.

## G-3055

### Roller Assembly

**Contents:** 2 roller assemblies.

**Description:** Nylon housing; flat edge nylon roller; fits on *Acorn* old style windows.

You may wish to stock these related parts: **F-2645, G-3058.**

## G-3056

### Roller Assembly

**Contents:** 2 roller assemblies.

**Description:** Nylon housing; flat edge nylon roller; fits on *Bee Cee* and other windows.

You may wish to stock these related parts: **F-2645, G-3058.**

## G-3167

### Roller Assembly

**Contents:** 2 roller assemblies.

**Description:** Nylon housing; flat edge steel roller; fits on *Pennco* and others.

## G-3151

### Roller Assembly

**Contents:** 2 roller assemblies.

**Description:** Black nylon housing; 17/32" diameter solid brass flat edge roller; brass axle; fits on *Rollyson Series 400* windows.

**G-3050**

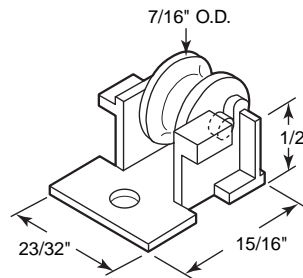
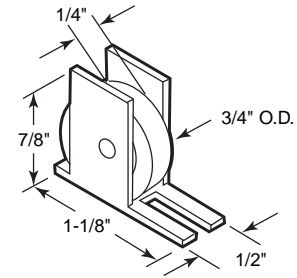

**G-3106**

**G-3147**

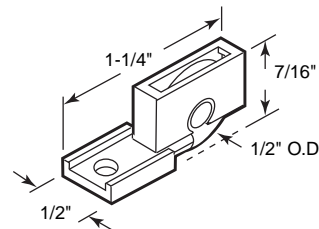
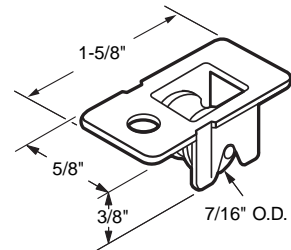

**G-3055**

Call for  
Availability

**G-3056**

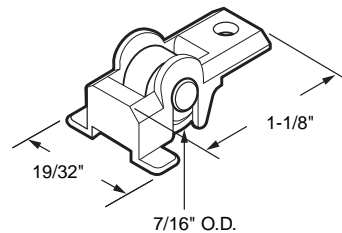
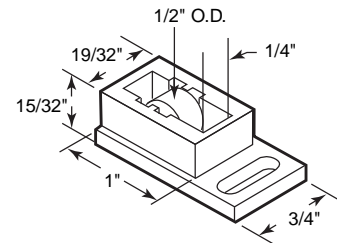

**G-3167**

**G-3151**

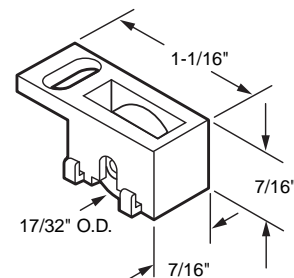

**G-3121**

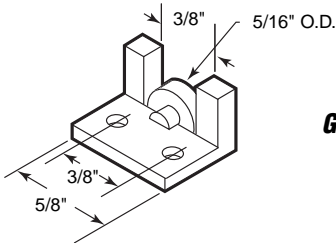
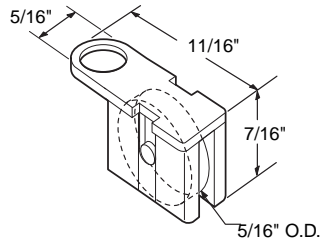

**G-3061**

**G-3143**

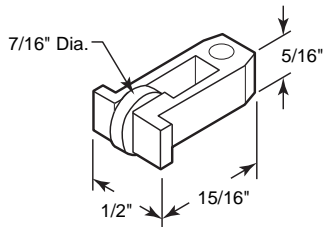
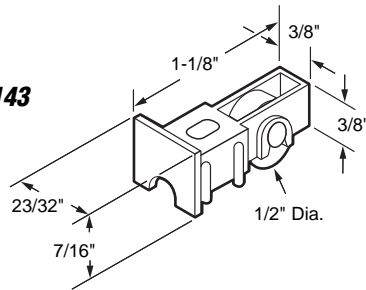

**G-3108**

**G-3126**

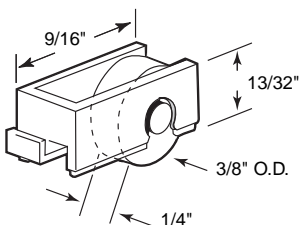
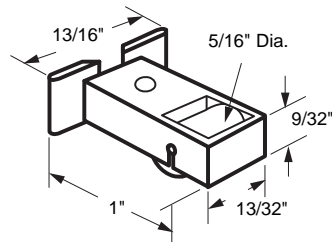

**G-3009**

**G-3169**

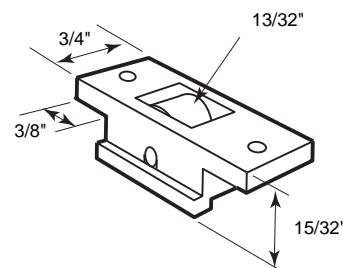

## G-3121

### Roller Assembly

**Contents:** 2 roller assemblies.

**Description:** Nylon housing; 5/16" diameter solid brass flat edge roller; fits on *Better-Bilt*.

You may wish to stock these related parts: F-2526, F-2627, F-2628, F-2642, G-3086.

## G-3061

### Roller Assembly

**Contents:** 2 roller assemblies.

**Description:** Nylon guide bracket; 5/16" diameter flat edge brass roller; fits on *Elco/Century* windows.

You may wish to stock these related parts: G-3118, G-3122, G-3135.

## G-3143

### Roller Assembly

**Contents:** 2 roller assemblies.

**Description:** Black nylon housing; 3/16" x 1/2" steel roller; fits on *Sun-Air* and others.

You may wish to stock these related parts: G-3084.

## G-3108

### Roller Assembly

**Contents:** 2 roller assemblies.

**Description:** Nylon housing and guide; 7/16" diameter flat edge steel roller.

## G-3126

### Roller Assembly

**Contents:** 2 roller assemblies.

**Description:** Nylon housing with 5/16" diameter flat edge steel roller.

## G-3009

### Roller Assembly

**Contents:** 2 roller assemblies.

**Description:** Nylon housing with 1/4" x 3/8" flat edge steel roller; fits on *Fullview* windows.

You may wish to stock these related parts: F-2553, G-3010, G-3011, G-3025, G-3026, G-3039, G-3082.

## G-3169

### Roller Assembly

**Contents:** 2 roller assemblies.

**Description:** Black Nylon housing with 13/32" diameter solid brass roller; fits on *Amsco* windows.

## G-3013

### Roller Assembly

**Contents:** 4 roller assemblies.

**Description:** Nylon housing with 1/8" x 1/2" flat edge nylon roller; fits on *L.J. Windows* and others.

**G-3013**

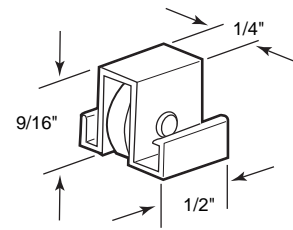

## G-3112

### Roller Assembly

**Contents:** 2 roller assemblies.

**Description:** Nylon housing; 5/8" diameter, flat edge nylon ball bearing roller; fits on *Premier Series 510* windows.

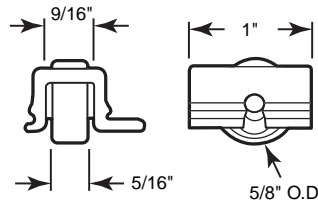

**G-3112**

## G-3012

### Roller Assembly

**Contents:** 2 roller assemblies.

**Description:** Nylon housing; 1/16" x 3/8" flat edge steel roller; fits on *Daryl*.

You may wish to stock these related parts: **F-2509**.

**G-3012**

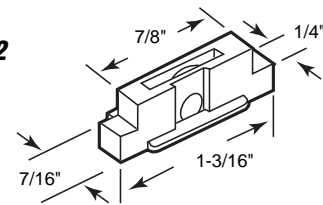

Call for Availability

## G-3044

### Roller Assembly

**Contents:** 2 roller assemblies.

**Description:** Nylon housing with flat edge nylon roller.

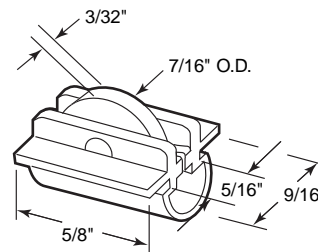

**G-3044**

Call for Availability

## G-3064

### Roller Assembly

**Contents:** 2 roller assemblies.

**Description:** Nylon housing; center groove nylon roller; fits on *Window Master*.

**NOTE:** Old style diecast housing is no longer available.

**G-3064**

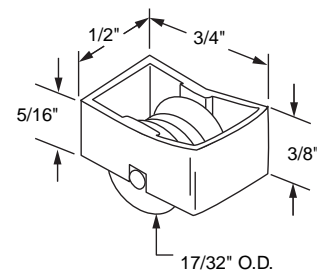

**G-3065**

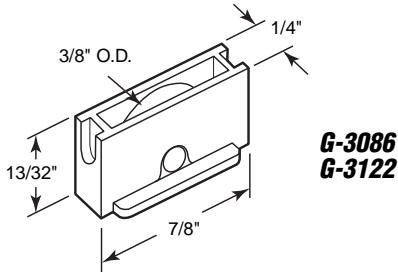
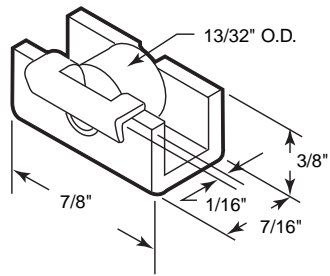

**G-3089**

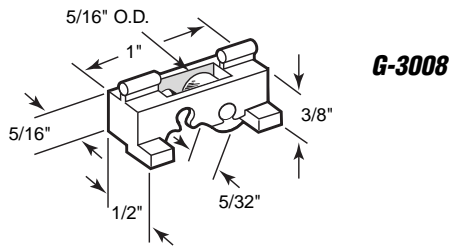
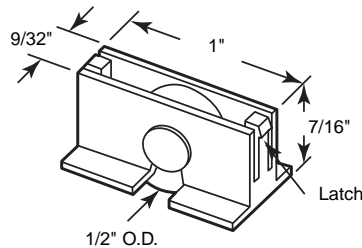

**G-3010**

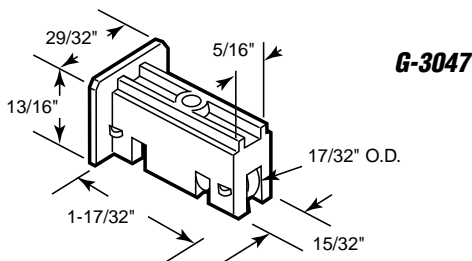
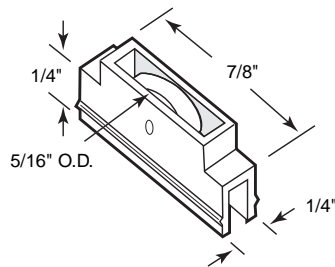

## G-3065

### Roller Assembly

**Contents:** 2 roller assemblies

**Description:** Nylon housing; 1/16" guide leg; flat edge nylon roller; fits on *Rolleze* windows.

You may wish to stock these related parts: F-2553, F-2608, G-3105.

## G-3086 (Nylon roller)

## G-3122 (Brass roller)

### Roller Assembly

**Contents:** 2 roller assemblies.

**Description:** Nylon housing; 3/8" diameter flat edge roller; fits on *Elco*, *Better-Bilt Aluminum* and others.

## G-3089

### Roller Assembly

**Contents:** 2 roller assemblies.

**Description:** Nylon housing with 1/2" diameter steel roller; fits on *Superlite Series 8000* windows.

## G-3008

### Roller and Guide Assembly

**Contents:** 2 roller assemblies.

**Description:** Adjustable nylon housing; 5/32" x 5/16" flat edge steel roller; 2 position height adjustment; fits on *Olson* and others.

## G-3010

### Roller Assembly

**Contents:** 2 roller assemblies.

**Description:** Nylon housing with 3/32" x 5/16" flat edge steel roller; fits on *Fullview* windows.

You may wish to stock these related parts: F-2553.

## G-3047

### Roller Assembly

**Contents:** 2 roller assemblies.

**Description:** Nylon housing with flat edge steel ball bearing roller; fits on *Bee Cee* windows and others.

You may wish to stock these related parts: F-2548, G-3056, G-3072.

Call for  
Availability

## G-3048

### Roller Assembly

**Contents:** 2 roller assemblies.

**Description:** Nylon housing; 5/8" diameter steel ball bearing roller; center grooved; snap-in design.

**G-3048**

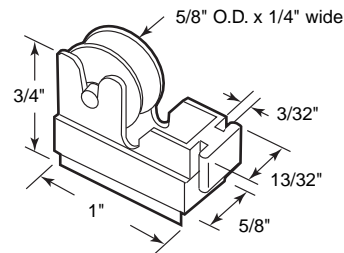

## G-3049

### Roller Assembly

**Contents:** 2 roller assemblies.

**Description:** Nylon housing; flat edge nylon ball bearing roller; designed for *Crossly* windows.

You may wish to stock these related parts: F-2529, F-2530.

**G-3049**

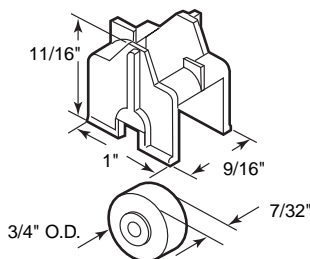

## G-3109

### Roller Assembly

**Contents:** 2 roller assemblies.

**Description:** Nylon housing; 5/16" x 5/16" flat edge steel roller; fits on *Keller Window*.

You may wish to stock these related parts: F-2541, F-2542, F-2644, G-3060, G-3126.

**G-3109**

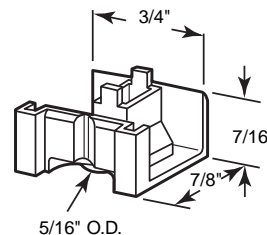

## G-3058

### Roller Assembly

**Contents:** 2 roller assemblies.

**Description:** Nylon housing; flat edge steel roller; fits on *Acorn "Series 2100"* thru *"Series 2300"* old style windows and others.

You may wish to stock these related parts: F-2645, G-3045, G-3055.

**G-3058**

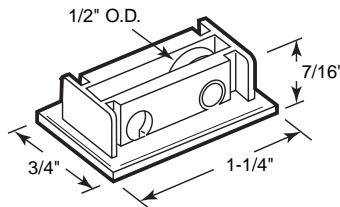

## G-3059

### Roller Assembly

**Contents:** 2 roller assemblies.

**Description:** Nylon housing; flat edge steel roller; fits on *Acorn "Series 2100"* thru *"Series 2300"* new style windows and others.

You may wish to stock these related parts: F-2645, G-3045, G-3055, G-3058.

**G-3059**

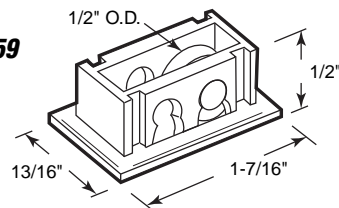

## G-3072

### Roller Assembly

**Contents:** 2 roller assemblies.

**Description:** Adjustable nylon housing; steel ball bearing roller; fits on *Thermo Glide*, *Bee Cee* and others.

You may wish to stock these related parts: F-2548, G-3047, G-3056, G-3101.

**G-3072**

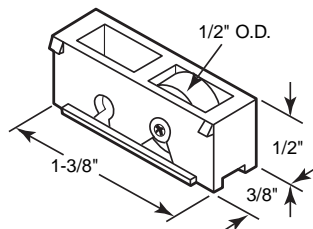

**G-3127**

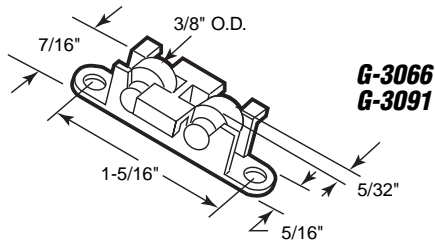
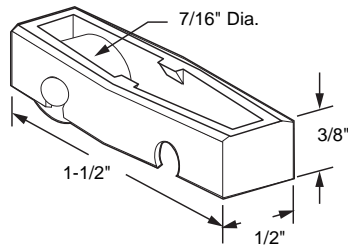

**G-3066**  
**G-3091**

**G-3107**

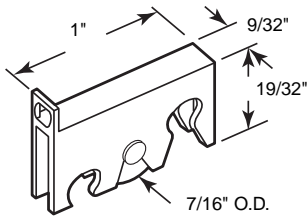
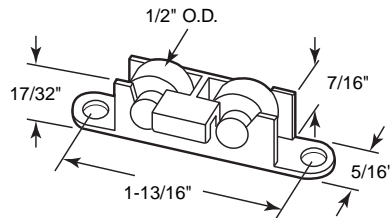

**G-3097**

**G-3043**

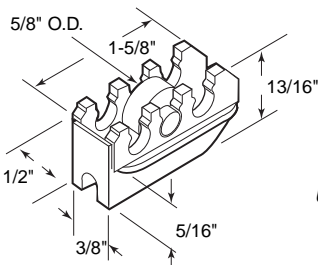
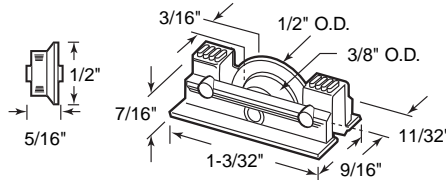

**G-3045**

**G-3127**

## Roller Assembly

**Contents:** 2 roller assemblies.

**Description:** Nylon housing; solid brass rollers; fits on *Capitol Windows 600 Series*.

You may wish to stock these related parts: **F-2529, F-2530**.

**G-3066** (Nylon roller)

**G-3091** (Brass roller)

## Roller Assembly

**Contents:** 2 roller assemblies.

**Description:** Nylon housing; flat edge tandem rollers; fits on *House of Aluminum* and others.

**G-3107**

## Roller Assembly

**Contents:** 2 roller assemblies.

**Description:** Nylon housing; flat edge tandem nylon rollers.

**G-3097**

## Roller Assembly

**Contents:** 2 roller assemblies.

**Description:** Nylon housing; 7/16" diameter steel roller; 3-height adjustment; fits on *Alenco*.

You may wish to stock these related parts: **G-3096, G-3100, G-3103, G-3117, G-3166**.

**G-3043**

## Roller Assembly

**Contents:** 2 roller assemblies.

**Description:** Nylon housing; flanged edge nylon roller; used on sliding windows.

Call for  
Availability

**G-3045**

## Roller Assembly

**Contents:** 2 roller assemblies.

**Description:** Plastic housing with flat edge steel roller; fits on *Acorn 2200 Series* windows.

You may wish to stock these related parts: **F-2645, G-3055, G-3058, G-3059**.

# Sliding Window Rollers & Guides

## G-3046

### Roller Assembly

**Contents:** 2 roller assemblies.

**Description:** Nylon housing with flat edge steel roller; fits on Capitol "Series 180" windows.

You may wish to stock these related parts: G-3127.

G-3046

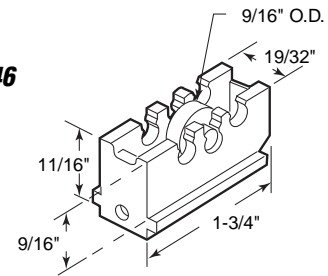

## G-3006

### Roller Assembly

**Contents:** 1 roller assembly.

**Description:** Nylon housing with 5/32" x 7/16" center groove steel roller; 3-position height adjustment; fits on Glasco windows.

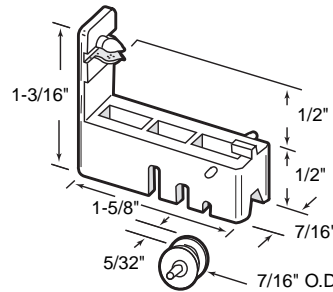

G-3006

## G-3007

### Roller Assembly

**Contents:** 1 roller assembly.

**Description:** Nylon housing; tandem roller design; 5/32" x 7/16" center groove steel rollers; 3 position height adjustment; fits on Pacific windows.

You may wish to stock these related parts: G-3063, G-3141.

Call for Availability

G-3007

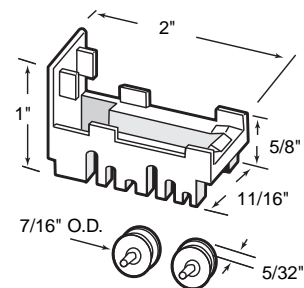

## G-3071

### Roller Assembly

**Contents:** 2 roller assemblies.

**Description:** Nylon housing; dual steel rollers; fits on Tomrays Tyco 77 dual glazed windows.

You may wish to stock these related parts: F-2547.

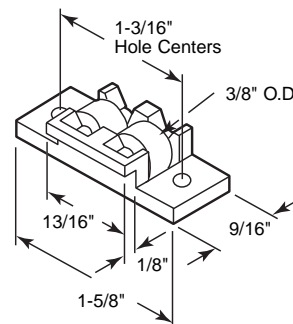

G-3071

## G-3119

### Roller Assembly

**Contents:** 2 roller assemblies.

**Description:** Nylon housing; flat edge brass rollers; used by several window manufacturers.

G-3119

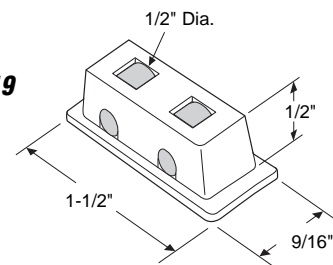

## G-3134

### Roller Assembly

**Contents:** 2 roller assemblies.

**Description:** Nylon housing; flat edge nylon rollers; used by several window manufacturers.

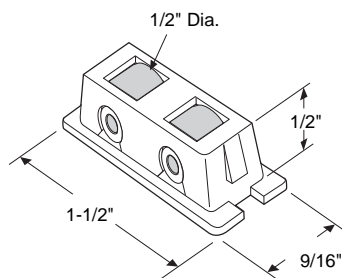

G-3134



**G-3136**

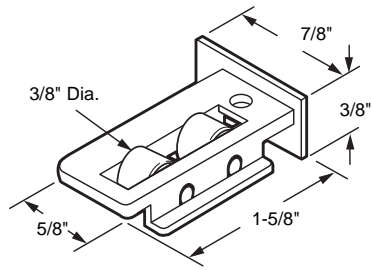

**G-3136**

**Roller Assembly** (Left and right)

**Contents:** 2 roller assemblies.

**Description:** White nylon housing with twin nylon rollers; brass axles; fits on *Premiere* windows.

You may wish to stock these related parts: **G-3015, G-3060, G-3088, G-3098, G-3122.**

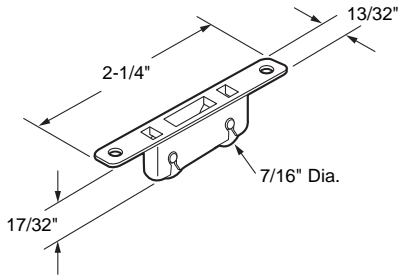

**G-3130**

**G-3130**

**Roller Assembly**

**Contents:** 2 roller assemblies.

**Description:** Nylon housing; 7/16" diameter solid brass rollers; used by several window manufacturers.

**G-3131**

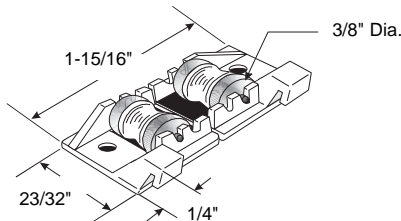

**G-3131**

**Roller Assembly**

**Contents:** 2 roller assemblies.

**Description:** White nylon housing; brass rollers; fits on *Merzon* windows.

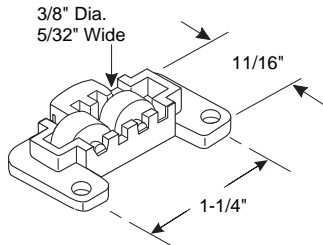

**G-3132**

**G-3132**

**Roller Assembly**

**Contents:** 2 roller assemblies.

**Description:** Black nylon housing; brass rollers; steel axles.

**G-3159**

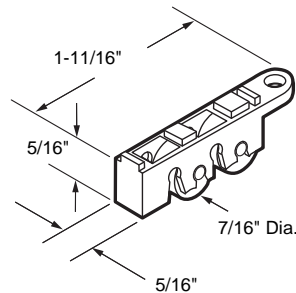

**G-3159**

**Roller Assembly**

**Contents:** 2 roller assemblies.

**Description:** Adjustable nylon housing; solid brass rollers.

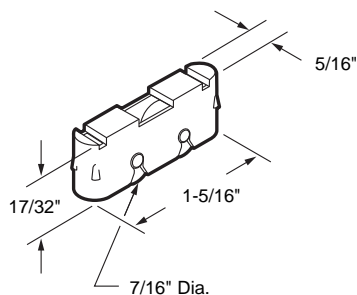

**G-3160**

**G-3160**

**Roller Assembly**

**Contents:** 2 roller assemblies.

**Description:** High quality nylon housing; tandem nylon rollers.

## G-3118

### Roller Assembly

**Contents:** 2 roller assemblies.

**Description:** Nylon housing; flat edge brass rollers; fits on *Elco/Century* windows.

You may wish to stock these related parts: **G-3061, G-3122, G-3135.**

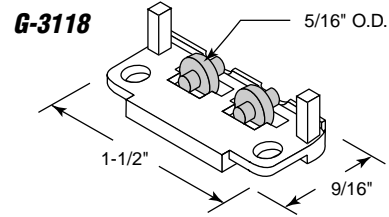

## G-3158

### Roller Assembly

**Contents:** 2 roller assemblies.

**Description:** White nylon housing; flat edge tandem steel rollers; fits on *A.B.C.* windows.

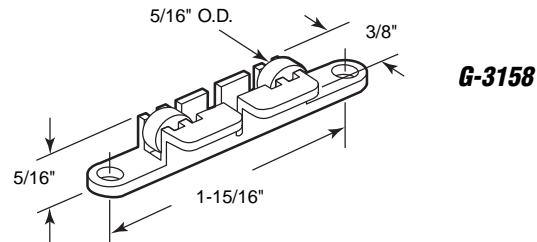

## G-3146

### Roller Assembly

**Contents:** 2 roller assemblies.

**Description:** White nylon housing; nylon rollers; fits by *Milgard* and others.

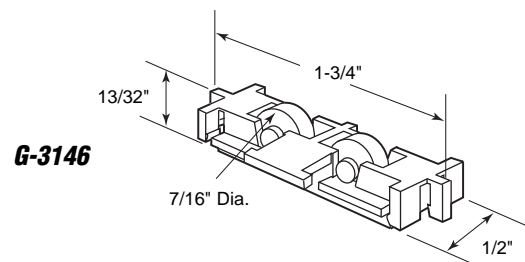

## G-3014 (Nylon ball bearing)

## G-3133 (Steel ball bearing)

### Roller Assembly

**Contents:** 2 roller assemblies.

**Description:** Used as a bottom roller on heavy sliding glass windows; adjustable steel housing with 7/32" x 27/32" center grooved roller.

You may wish to stock these related parts: **G-3073.**

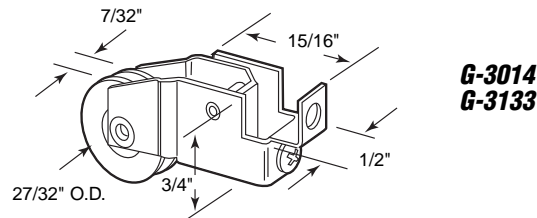

## G-3099

### Roller Assembly

**Contents:** 1 roller assembly.

**Description:** Steel adjustable housing; 13/16" diameter flat edge nylon ball bearing roller; fits on *Likit* windows.

You may wish to stock these related parts: **F-2513, F-2514, G-3078, G-3079, G-3080, G-3081, G-3113.**

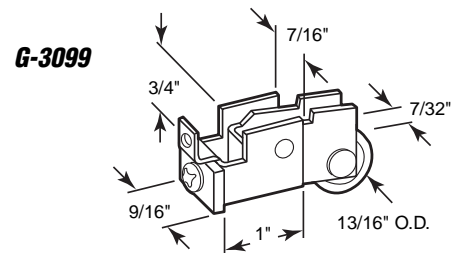

## G-3129

### Roller Assembly

**Contents:** 2 roller assemblies.

**Description:** Nylon housing; 15/32" diameter twin, flat edge, solid brass rollers; stainless steel axles.

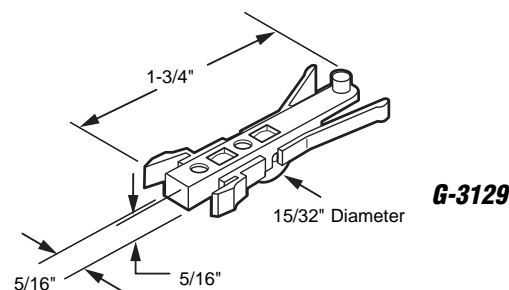

**G-3166**

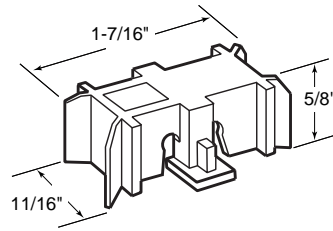

**G-3166**

**Roller Assembly**

**Contents:** 2 roller assemblies.

**Description:** Adjustable white nylon housing; 1/2" diameter flat edge steel roller; fits on *Alenco*.

You may wish to stock these related parts: **G-3096, G-3097, G-3100, G-3103, G-3117.**

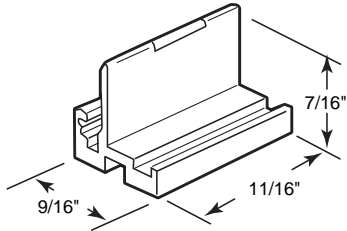

**G-3025**

**G-3025**

**Top Guide**

**Contents:** 4 guides.

**Description:** Nylon top guide for *Fullview* windows.

You may wish to stock these related parts: **F-2553, G-3009, G-3010, G-3011, G-3026, G-3039, G-3082.**

*Call for Availability*

**G-3026**

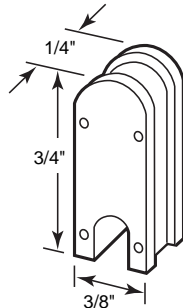

**G-3026**

**Top Guide**

**Contents:** 6 guides.

**Description:** Nylon top guide and anti-rattler; fits on *Fullview* windows.

You may wish to stock these related parts: **F-2553, G-3009, G-3010, G-3011, G-3039, G-3082.**

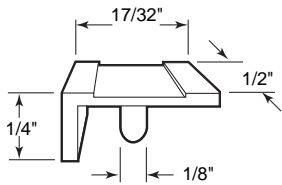

**G-3027**

**G-3027**

**Top Guide**

**Contents:** 4 guides.

**Description:** Nylon top guide and anti-rattler; fits on *Hallmark* windows; popular on recreation vehicles.

You may wish to stock these related parts: **F-2510, F-2511, F-2585, F-2586.**

*Call for Availability*

**G-3062**

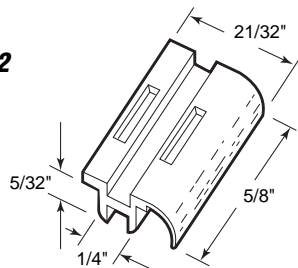

**G-3062**

**Top Guide**

**Contents:** 4 guides.

**Description:** Nylon top guide fits on *Radco* old style windows; snap-in design.

You may wish to stock these related parts: **G-3028, G-3029, G-3030, G-3031, G-3153.**

*Call for Availability*

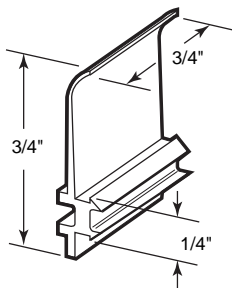

**G-3063**

**G-3063**

**Top Guide**

**Contents:** 4 guides.

**Description:** Nylon top guide; fits on *Pacific* old style windows.

You may wish to stock these related parts: **G-3007, G-3141.**

# Sliding Window Rollers & Guides

## G-3069

### Top Guide

**Contents:** 4 guides.

**Description:** Black nylon top guide and anti-rattler; popular on mobile homes; fits on *Phillips* windows.

You may wish to stock these related parts: **G-3070**.

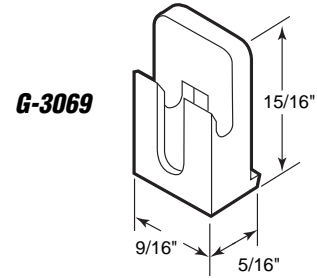

## G-3103

### Top Guide

**Contents:** 4 guides.

**Description:** Nylon top guide for sliding aluminum windows; snap-in design; fits on *Alenco*.

You may wish to stock these related parts: **G-3096, G-3097, G-3100, G-3117**.

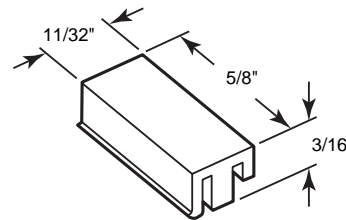

## G-3028

### Top Guide

**Contents:** 4 guides.

**Description:** Plastic top guide; snap-in design; fits on *Radco* windows.

You may wish to stock these related parts: **G-3029, G-3030, G-3031, G-3062, G-3153**.

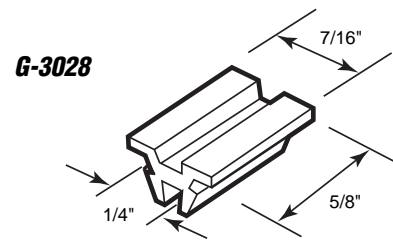

## G-3141

### Top Guide

**Contents:** 4 guides.

**Description:** Gray nylon top guide; snap-in design; fits on *Pacific Window* and others.

You may wish to stock these related parts: **G-3007, G-3063**.

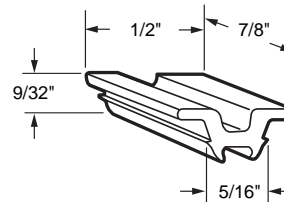

## G-3154

### Top Guide

**Contents:** 4 guides.

**Description:** Nylon top guide; fits on *International* sliding aluminum windows.

You may wish to stock these related parts: **F-2521, G-3000, G-3074, G-3102**.

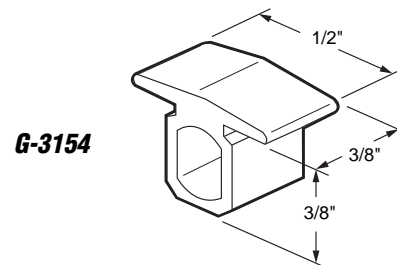

## G-3110

### Bottom Guide

**Contents:** 2 guides.

**Description:** Nylon bottom guide; fits on *Mayfair* windows.

You may wish to stock these related parts: **G-3023, G-3104**.

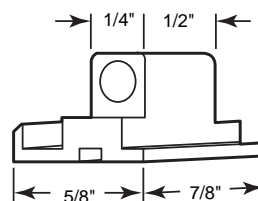

Call for  
Availability

**G-3114**

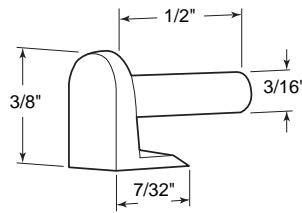

**G-3114**

**Bottom Guide**

**Contents:** 4 guides.

**Description:** Nylon bottom guide; snap-in design; corner mounted; acts as a glide on sliding aluminum windows.

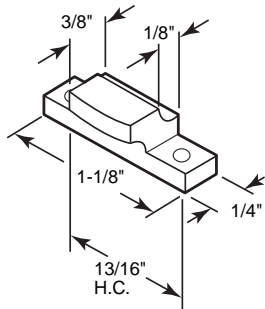

**G-3070**

**G-3070**

**Bottom Glide**

**Contents:** 4 glides.

**Description:** Black nylon bottom glide; also serves as a guide; popular on mobile homes; fits on *Phillips* windows.

You may wish to stock these related parts: **F-2623, G-3069, G-3132.**

**G-3081**

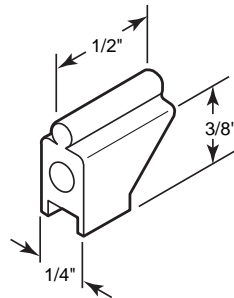

**G-3081**

**Bottom Glide**

**Contents:** 4 glides.

**Description:** Nylon glide; installs on bottom of window to act as a roller; fits on *Likit* windows.

You may wish to stock these related parts: **F-2513, F-2514, G-3099.**

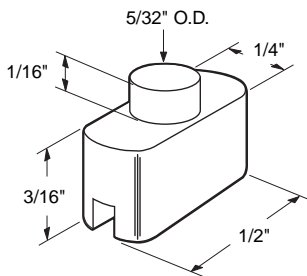

**G-3096**

**G-3096**

**Bottom Glide**

**Contents:** 4 glides.

**Description:** Nylon glide snaps into hole in bottom vent rail; fits on *Alenco*.

You may wish to stock these related parts: **G-3097, G-3100, G-3103.**

**G-3100**

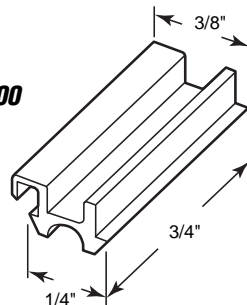

**G-3100**

**Bottom Glide**

**Contents:** 4 glides.

**Description:** Nylon glide acts as a roller on sliding aluminum windows; fits on *Alenco*.

You may wish to stock these related parts: **G-3103, G-3117.**

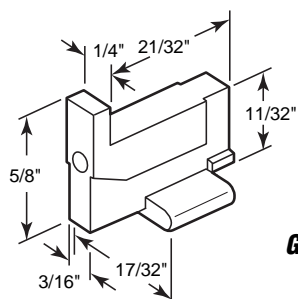

**G-3104**

**G-3104**

**Bottom Glide**

**Contents:** 2 glides.

**Description:** Nylon corner and bottom glide act as a roller on sliding aluminum windows; fits on *Mayfair* windows.

You may wish to stock these related parts: **G-3023, G-3110.**

# Sliding Window Rollers & Guides

## G-3080

### Guide

**Contents:** 4 guides.

**Description:** Nylon guide; installs on lock side of window; fits on *Likit* windows.

You may wish to stock these related parts: **G-3099**.

## G-3115

### Guide

**Contents:** 6 guides.

**Description:** Nylon guide; snap-in design; used on both top and bottom of window.

## G-3029

### Guide

**Contents:** 4 guides.

**Description:** Plastic snap-in style guide; fits on *Radco* windows.

You may wish to stock these related parts: **G-3153**.

## G-3113

### Guide

**Contents:** 4 guides.

**Description:** Nylon guide; snap-in design; fits on *Likit* windows.

You may wish to stock these related parts: **F-2513**, **F-2514**.

## G-3142

### Guide

**Contents:** 4 guides.

**Description:** White nylon guide; fits on *Guaranteed Products* and other window manufacturers.

You may wish to stock these related parts: **F-2512**, **F-2597**, **F-2647**.

## G-3079

### Guide and Bumper

**Contents:** 4 guides.

**Description:** Nylon guide; installs on lock side of window; fits on *Likit* windows.

You may wish to stock these related parts: **F-2513**, **F-2514**, **G-3099**.

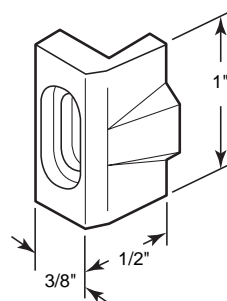
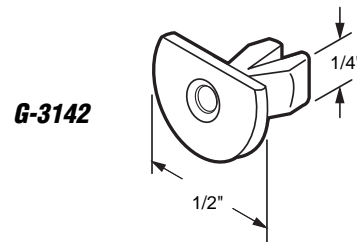
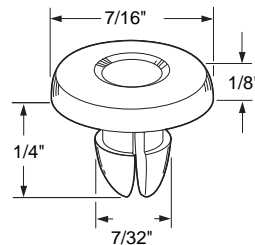
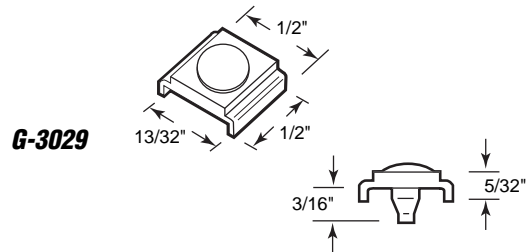
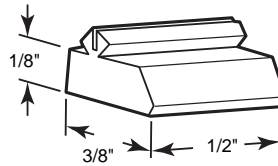
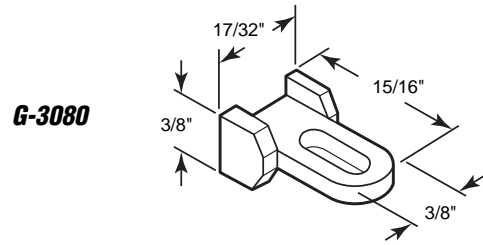

**G-3079**

**G-3078**  
**G-3078A**  
**G-3078B**  
**G-3078C**  
**G-3078D**

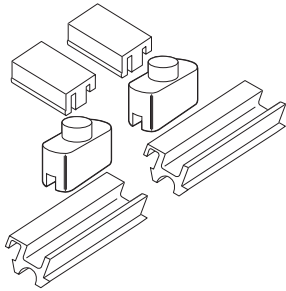
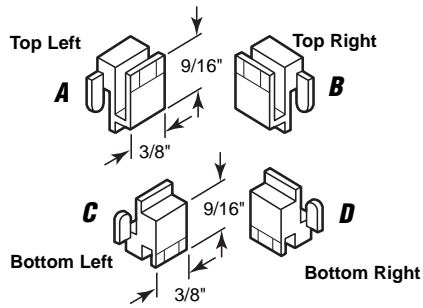

**G-3117**

**G-3022**  
**G-3022B**

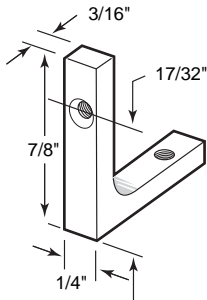
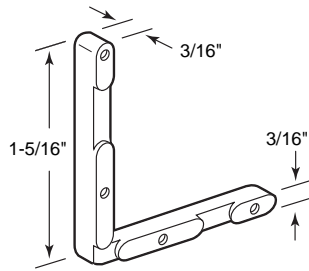

**G-3024**  
**G-3024B**

**G-3057**

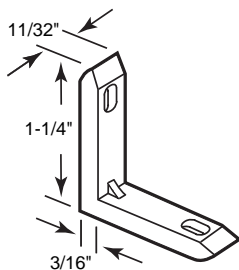
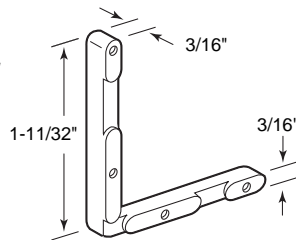

**G-3023**

**G-3078**

**G-3078A** (100/box - top left)

**G-3078B** (100/box - top right)

**G-3078C** (100/box - bottom left)

**G-3078D** (100/box - bottom right)

## Corner Guide Set

**Contents:** 4 guides.

**Description:** Nylon guides mount on each corner and act as a glide and guide; fits on *Likit* windows.

You may wish to stock these related parts: **F-2513**, **F-2514**, **G-3099**.

## G-3117

### "Alenco" Repair Kit

**Contents:** 2 each - top guides, bottom glides (old style) and bottom glides (new style)

**Description:** Nylon guide and glides; snap-in application; fits to repair *Alenco Series 200* sliding windows, either new or old style.

**G-3022** (8 per card)

**G-3022B** (100 per box)

## Corner Insert

**Contents:** Diecast corners.

**Description:** Inserts into window frame extrusion to hold frame together; fits on *Bel-Air*.

**G-3024** (4 per card)

**G-3024B** (100 per box)

## Corner Insert

**Contents:** Extruded aluminum corners; no. 5-40 x 5/16" Phillips flat head machine screws.

**Description:** Inserts into window extrusion to hold frame together; fits on *Rylock* windows.

## G-3057

### Corner Insert

**Contents:** 8 corners.

**Description:** Diecast corner; attaches to window frame by indenting frame with punch; designed to fit "*C*" Sash frame.

## G-3023

### Corner Insert

**Contents:** 4 diecast corners.

**Description:** Inserts into window extrusion to hold frame together; fits on *Mayfair* windows.

# Sliding Window Rollers & Guides

## G-3155

### Corner Insert

**Contents:** 4 corners.

**Description:** Zinc diecast corner inserts; fits on *Rylock* and others.

## G-3021

### Corner Insert & Roller

**Contents:** 2 corners.

**Description:** Diecast corner insert with  $7/32" \times 5/8"$  nylon rollers; fits on *Trimview*.

Call for  
Availability

**Contact our . . . .**

Customer Service Department  
for a much larger selection  
of corner keys and tilt keys!

G-3155

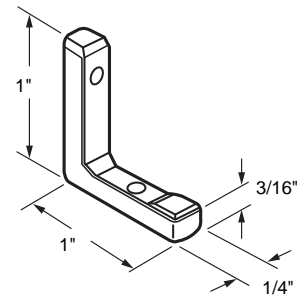

G-3021

