

E-2008

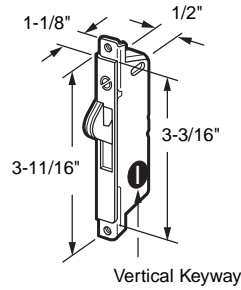

Vertical Keyway

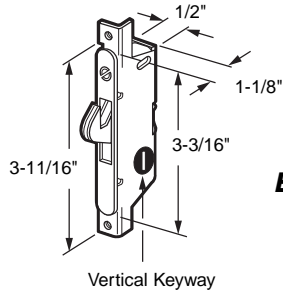

E-2009

Vertical Keyway

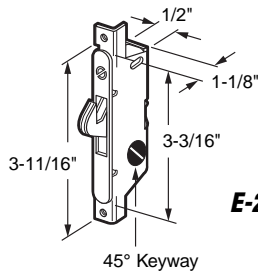

E-2121

45° Keyway

E-2111

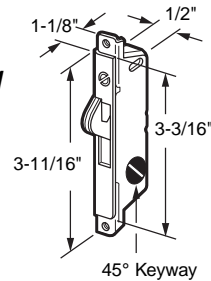

45° Keyway

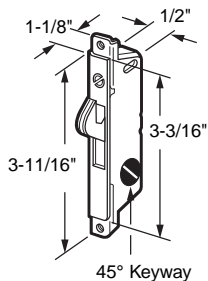

E-2118

45° Keyway

**E-2119
E-2148**

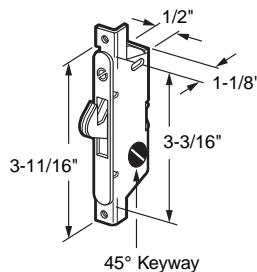

45° Keyway

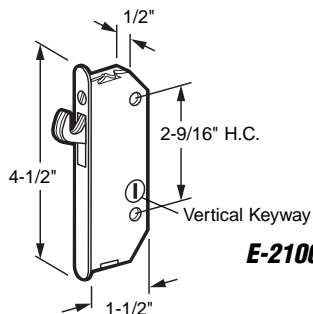

E-2100

E-2008

Mortise Lock

Contents: 1 lock; installation fasteners.

Description: Mortise installation; **steel housing and hook; square end face plate;** keyway is in **vertical position** with hook fully extended; hook projection is adjustable; fits on **Adams Rite**.

You may wish to stock these related parts: **C-1019, C-1035, C-1040, C-1050.**

E-2009

Mortise Lock

Contents: 1 lock; installation fasteners.

Description: Mortise installation; **steel housing and hook; round end face plate;** keyway is in **vertical position** with hook fully extended; hook projection is adjustable; fits on **Adams Rite**.

E-2111

E-2121

Mortise Lock

Contents: 1 lock; installation fasteners.

Description: Mortise installation; **steel housing and hook; round or square end face plate;** keyway is in the **45° position** with hook fully extended; hook projection is adjustable; fits on **Adams Rite**.

E-2118 (45° keyway)

Mortise Lock (Automatic)

Contents: 1 lock; installation fasteners.

Description: **Steel housing and hook;** hook is spring loaded; with adjustable projection; does not hold back in unlocked position; **automatically latches door; square end face plate;** keyway is in the **45° position** with hook fully extended; fits on **Adams Rite**.

E-2119 (Steel)

E-2148 (Stainless steel)

Mortise Lock (Automatic)

Contents: 1 lock; installation fasteners.

Description: Mortise installation; **steel housing and hook;** hook is spring loaded; with adjustable hook projection; **automatically latches door; round end face plate;** keyway is in the **45° position** with hook fully extended; fits on **Adams Rite**.

E-2100 (Vertical keyway)

Mortise lock

Contents: 1 lock.

Description: **Stainless steel** mortise latch; adjustable bolt throw; will withstand approx. 1000 pound force horizontally and vertically to resist pry bar attack or to lift door off track.

You may wish to stock these related parts: **C-1058, E-2034.**

Sliding Patio Door

E-2012

Mortise Lock

Contents: 1 lock; installation fasteners.

Description: Mortise installation; **steel housing and hook; square end face plate;** keyway is in **vertical position** with hook fully extended; hook projection is adjustable; fits on **W&F**.

You may wish to stock these related parts: **C-1035, C-1039, C-1040, E-2101.**

E-2013

Mortise Lock

Contents: 1 lock; installation fasteners.

Description: Mortise installation; **steel housing and hook; round end face plate;** keyway is in **vertical position** with hook fully extended; hook projection is adjustable; fits on **W&F**.

You may wish to stock these related parts: **C-1035, C-1039, C-1040, E-2101.**

E-2014

Mortise Lock

Contents: 1 lock; installation fasteners.

Description: Mortise installation; **steel housing and hook; round end face plate;** keyway is in the **45° position** with hook fully extended; hook projection is adjustable; fits on **W&F**.

You may wish to stock these related parts: **C-1019, C-1035, C-1040, C-1058, E-2101.**

E-2079

Mortise Lock and Keeper

Contents: 1 lock and keeper assembly with complete set of fasteners.

Description: Excellent for either **wood** or **aluminum** door application; integration of keeper and lock for positive **anti-lift** protection; **plated steel hook** is mounted in an **anti-friction pivot**, encased in **aluminum housing**; fits on **Pennco** and other manufacturers. Overall depth is 1-3/16".

You may also wish to stock these related parts: **C-1058, C-1131, E-2134.**

E-2126

Mortise Lock and Keeper (Large housing)

Contents: 1 lock and keeper assembly with complete set of fasteners.

Description: Excellent for either **wood** or **aluminum** door application; integration of keeper and lock for positive **anti-lift** protection; **plated steel hook** is mounted in an **anti-friction pivot**, encased in **aluminum housing**; fits on **Traco** and other manufacturers. Overall depth is 1-9/16".

You may also wish to stock these related parts: **C-1058, C-1131.**

E-2128

Mortise Lock

Contents: 1 lock; installation fasteners.

Description: **Diecast** construction; mortise lock for **wood** doors; used exclusively in Canada.

You may wish to stock these related parts: **E-2034.**

Call for
Availability

E-2012

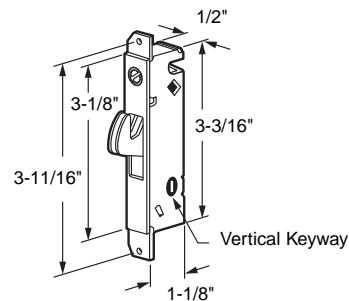

E-2013

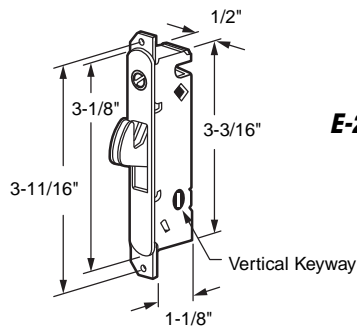

E-2014

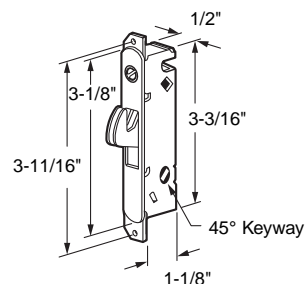

E-2079

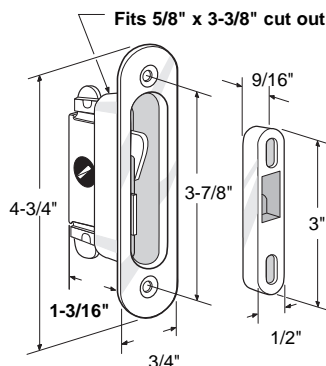

E-2126

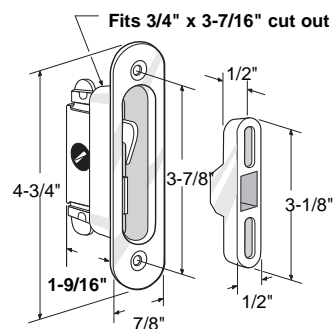

E-2128

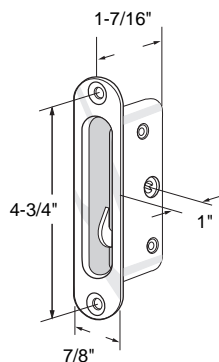

E-2027

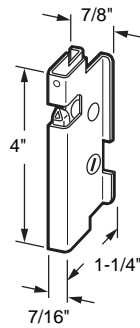

E-2069

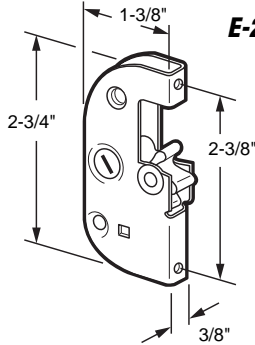

E-2080

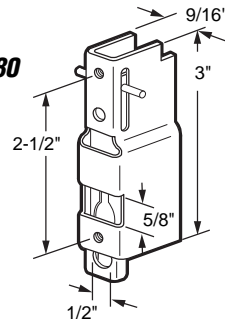

E-2026

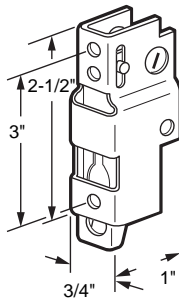

E-2025

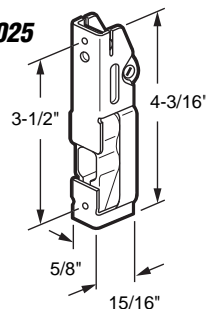

E-2010

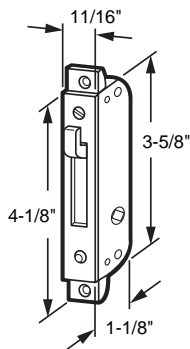

E-2027

Mortise Lock

Contents: 1 lock; installation fasteners.

Description: Mortise installation; **steel housing**; fits on *Daryl Industries*.

You may wish to stock these related parts: **C-1035, C-1036, E-2028.**

E-2069

Mortise Lock

Contents: 1 lock; installation fasteners.

Description: **Cog type lock** assembly for old style *Arcadia* doors. **Diecast cog** and **steel housing**.

E-2080

Mortise Lock

Contents: 1 lock; installation fasteners.

Description: Mortise installation; **steel lock and housing**; fits on *Guaranteed Products*.

You may wish to stock these related parts: **C-1028, C-1029, E-2007, E-2109.**

E-2026

Mortise Lock

Contents: 1 lock; installation fasteners.

Description: Mortise installation; **steel lock and housing**; fits on *Northrop*.

You may wish to stock these related parts: **E-2109.**

E-2025

Mortise Lock

Contents: 1 lock; installation fasteners.

Description: **Steel lock and housing with stainless steel spring**; mortise installation; fits on *Northrop*.

You may wish to stock these related parts: **E-2109.**

E-2010

Mortise Lock

Contents: 1 lock; installation fasteners.

Description: **Diecast lock housing; steel hook and safety release button**; fits on *Parlyn 900* series

Call for
Availability

E-2021

Mortise Lock

Contents: 1 lock; installation fasteners.

Description: Mortise installation; **steel housing; square end face plate;** mounting flanges have no. 6-32 threaded holes; fits on **W & F.**

Call for Availability

E-2021

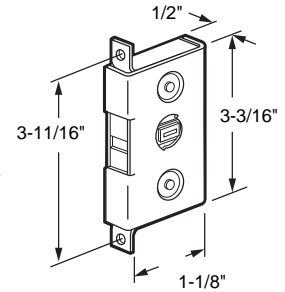

E-2022

Mortise Lock

Contents: 1 lock; installation fasteners.

Description: Mortise installation; **steel housing; round end face plate;** mounting flanges have no. 6-32 threaded holes; fits on **W&F.**

Call for Availability

E-2022

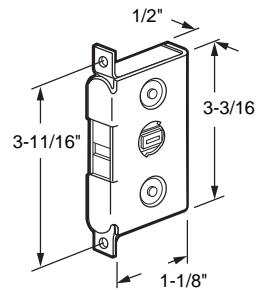

E-2011 (45° keyway)

Mortise Lock

Contents: 1 lock; installation fasteners.

Description: Mortise installation; **steel housing and hook; square end face plate;** fits on **Arcadia & Saurenman.**

You may wish to stock these related parts: **C-1035.**

Call for Availability

E-2011

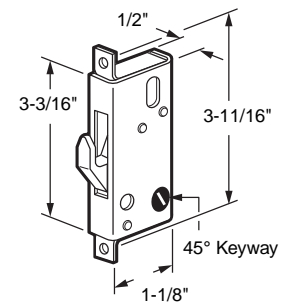

E-2030

Internal Lock

Contents: 1 lock; installation fasteners.

Description: Internal lock for surface mounted patio door handle set. **Steel housing and hook; black plastic** latch lever; with adjustable hook projection; fits on **Northrop Architectural** and other manufacturers.

E-2030

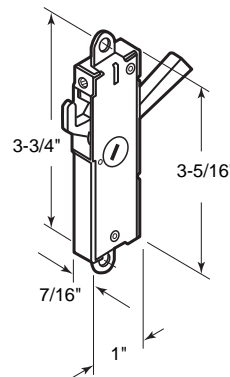

E-2029

Internal Lock

Contents: 1 lock; installation fasteners.

Description: Internal lock for surface mounted patio door handle, with **steel housing and hook; black plastic** latch lever; fits on **Adams Rite.**

You may wish to stock these related parts: **C-1048, C-1084, C-1093.**

E-2029

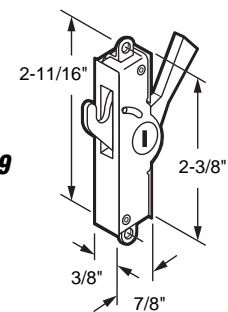

E-2077

Internal Lock

Contents: 1 lock; 1 retainer clip.

Description: **Diecast lock housing** with **steel hook and latch lever;** **plastic** retainer clip.

You may wish to stock these related parts: **C-1000, C-1001, C-1060, C-1061, C-1070, C-1071.**

E-2077

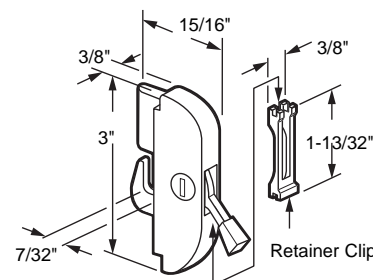

E-2105

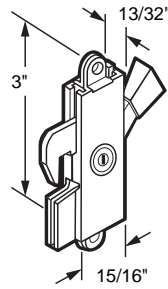

E-2105
Internal Lock

Contents: 1 lock.

Description: Stamped aluminum housing with steel hook and latch lever; black plastic latch lever tip.

You may wish to stock these related parts: **E-2029, E-2030, E-2077.**

E-2084

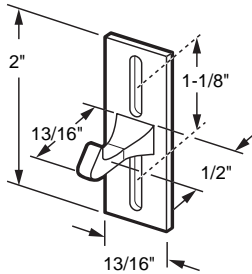

E-2084 (Chrome)
Keeper

Contents: 1 keeper; installation fasteners.

Description: Diecast, face mount keeper; vertical slots allow for adjustment; fits on *Miller Industries*.

You may wish to stock these related parts: **C-1086.**

E-2089

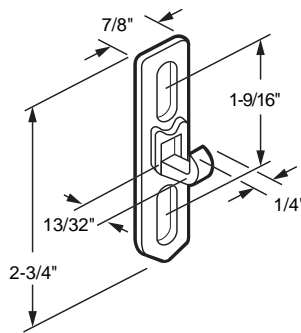

E-2089 (Chrome)
Keeper

Contents: 1 keeper; installation fasteners.

Description: Diecast, face mount keeper; vertical slots allow for adjustment; fits on *Daryl Industries*.

You may wish to stock these related parts: **C-1068, C-1074, E-2083.**

E-2083

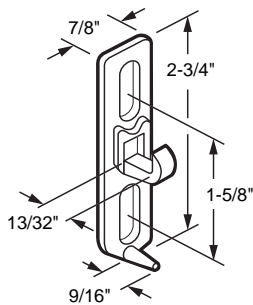

E-2083 (Chrome)
Keeper

Contents: 1 keeper; installation fasteners.

Description: Diecast, face mount keeper; vertical slots allow for adjustment; fits on *Crossly*.

You may wish to stock these related parts: **C-1068, C-1074, E-2083.**

E-2093

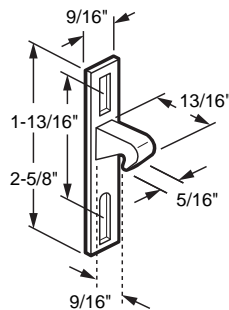

E-2093
Keeper

Contents: 1 keeper; installation fasteners.

Description: Zinc plated diecast keeper; face mount; vertical slots allow for adjustment.

You may wish to stock these related parts: **C-1018, E-2054.**

E-2137

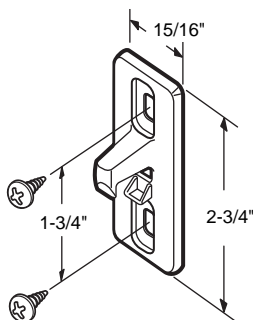

E-2137
Keeper

Contents: 1 keeper; installation fasteners.

Description: Zinc plated diecast keeper with vertical slots for adjustment, fits *Daryl* and other doors.

You may wish to stock these related parts: **C-1025, E-2003, E-2004.**

Sliding Patio Door

E-2098 (Chrome)

Keeper

Contents: 1 keeper; installation fasteners.

Description: Diecast keeper, face mount; anti-lift pin; vertical slots allow for adjustment.

You may wish to stock these related parts: C-1032, C-1033, C-1045, C-1075.

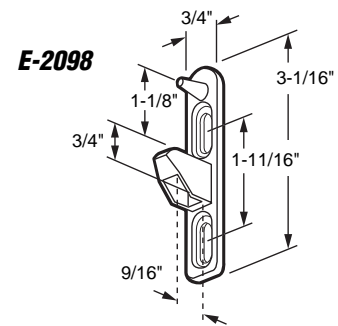

**E-2040
E-2082
E-2099**

E-2040 (3/4" wide - chrome)

E-2082 (1/2" wide - chrome)

E-2099 (3/4" wide - black)

Keeper

Contents: 1 keeper; installation fasteners.

Description: Diecast keeper; screw slots allow for vertical adjustment; universal application.

You may wish to stock these related parts: C-1032, C-1033, C-1045, C-1075, C-1076.

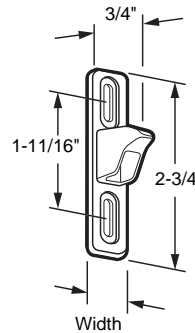

E-2020

Keeper

Contents: 1 keeper; installation fasteners.

Description: Surface mount; for hook style latch; 1/4" projection; plated steel; fits on W&F.

*Call for
Availability*

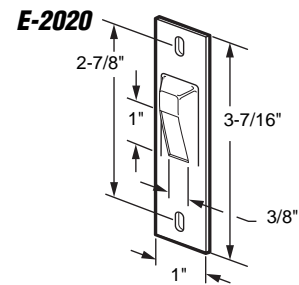

E-2019

Keeper

Contents: 1 keeper; installation fasteners.

Description: Surface mount; for hook style latch; 1/4" projection; plated steel; fits on W&F.

You may wish to stock these related parts: E-2013, E-2014.

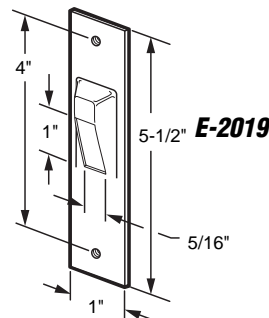

E-2041

Keeper

Contents: 1 keeper; installation fasteners.

Description: Diecast keeper and rubber bumper; repair part for sliding patio door handle C-1025.

You may wish to stock these related parts: C-1025, E-2003, E-2004.

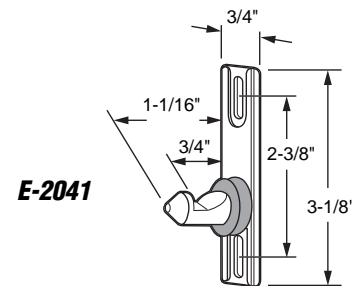

E-2096 (Chrome)

Keeper

Contents: 1 keeper; installation fasteners.

Description: Diecast, face mount keeper; vertical slots allow for adjustment; fits on Capitol & Parlyn.

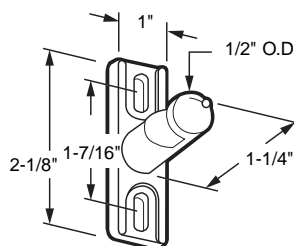

E-2096

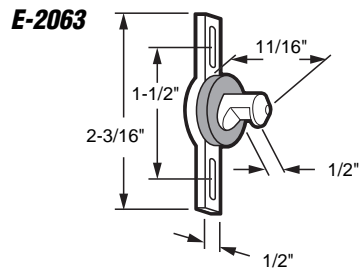

E-2063 Keeper (Narrow)

Call for Availability

Contents: 1 keeper; installation fasteners.

Description: Diecast keeper with round rubber bumper; fits on *Trimview* doors.

You may wish to stock these related parts: **E-2041**.

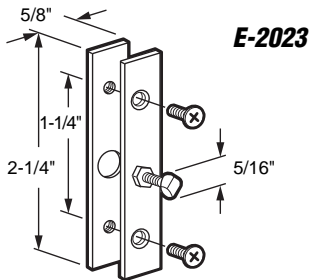

E-2023 Keeper

Call for Availability

Contents: 1 keeper; 1 backup plate; installation fasteners.

Description: Surface mount; for jaw style latch; plated steel; fits on *W&F*.

You may also wish to stock these related parts: **E-2008** thru **E-2014**.

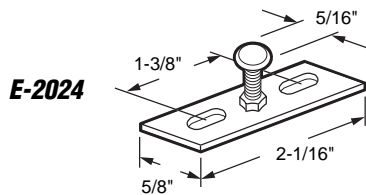

E-2024 Keeper

Call for Availability

Contents: 1 keeper; installation fasteners.

Description: Surface mount; for jaw style latch; adjustable; plated steel; fits on *W&F*.

You may wish to stock these related parts: **E-2109**.

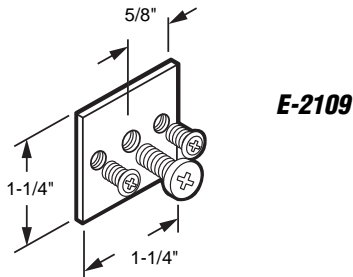

E-2109 Keeper

Contents: 1 keeper; 1 set of installation fasteners.

Description: Adjustable keeper assembly; fits on *Guaranteed Products*.

You may wish to stock these related parts: **C-1028**, **E-2080**.

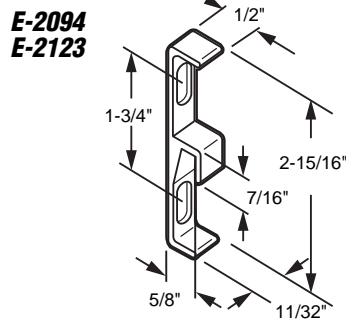

E-2094 (Aluminum) E-2123 (White) Keeper

Contents: 1 keeper; installation fasteners.

Description: Zinc diecast keeper; face mount; vertical slots allow for adjustment.

You may wish to stock these related parts: **C-1000**; **C-1001**, **E-2046**.

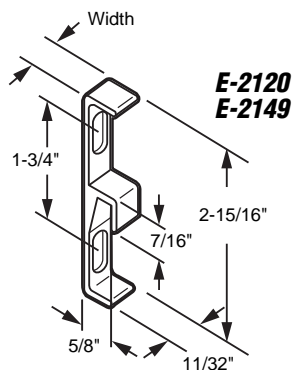

E-2120 (Wide - 3/4") E-2149 (Wide - 3/8") Keeper

Contents: 1 keeper; installation fasteners.

Description: Extruded aluminum keeper; face mount design; vertical slots allow for adjustment.

You may wish to stock these related parts: **E-2042**, **E-2044**, **E-2046**, **E-2094**.

Sliding Patio Door

E-2142 (Aluminum)

E-2143 (Bronze)

Keeper

Contents: 1 keeper; 1 angle bracket; installation fasteners.

Description: Extruded aluminum face mount keeper with 1/2" x 1/2" angle bracket; used as special anti-burglar plate.

E-2046 (Aluminum)

E-2047 (Black)

Keeper

Contents: 1 keeper; 1 angle bracket; installation fasteners.

Description: Zinc diecast face mount keeper with 1/2" x 1/2" angle bracket; used as special anti-burglar plate.

You may wish to stock these related parts: **C-1000, C-1001, C-1002, C-1004, E-2094.**

E-2048 (Aluminum)

E-2049 (Black)

Keeper

Contents: 1 keeper; installation fasteners.

Description: Extruded aluminum face mount keeper; screw slots allow for vertical adjustment.

You may wish to stock these related parts: **C-1000, C-1001, C-1079.**

E-2042 (Aluminum)

E-2043 (Black)

Keeper

Contents: 1 keeper; installation fasteners.

Description: Extruded aluminum keeper; face mount; designed for use on 4-1/2" jamb.

You may wish to stock these related parts: **C-1001, C-1021.**

E-2044 (Aluminum)

E-2045* (Black)

Keeper

Contents: 1 keeper; installation fasteners.

Description: Extruded aluminum keeper; designed for use on 5-1/2" wide jamb, fits on *Sears* sliding doors.

* *Call for availability on this item.*

You may wish to stock these related parts: **C-1001, C-1021.**

E-2131 (Aluminum)

Keeper

Contents: 1 keeper; installation fasteners.

Description: Extruded aluminum keeper; designed for use on *Unit Span* doors.

E-2142
E-2143

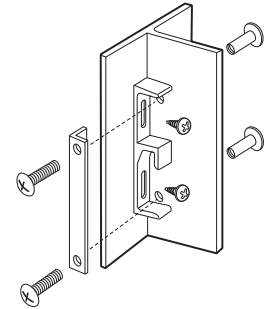
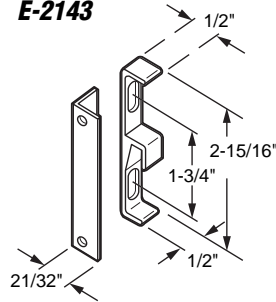

E-2046
E-2047

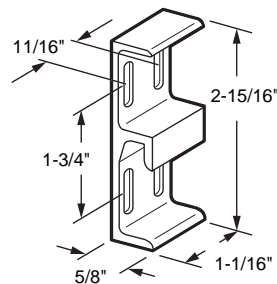

E-2048
E-2049

*Call for
Availability*

E-2042
E-2043

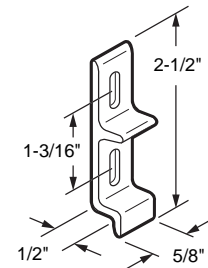

E-2044
E-2045*

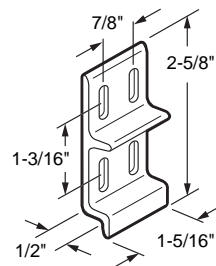

E-2131

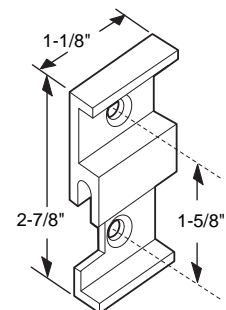

E-2016

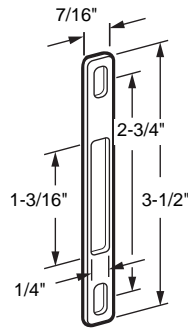

E-2016

Keeper (Narrow)

Contents: 1 keeper; installation fasteners.

Description: Surface mount; for hook style latch; **zinc plated steel**. Can be used as a reinforcing plate for slotted end stiles.

You may also wish to stock these related parts: **E-2008 thru E-2014**.

E-2017

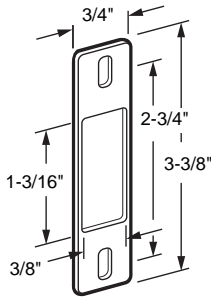

E-2017

Keeper (Wide)

Contents: 1 keeper; installation fasteners.

Description: Surface mount; for hook style latch; **stainless steel**; can be used as a reinforcing plate for slotted end stiles.

You may wish to stock these related parts: **E-2008 thru E-2014**.

E-2097

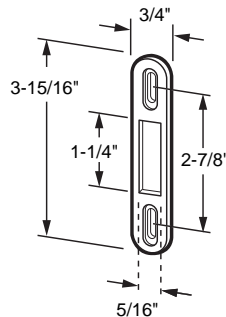

E-2097

Keeper

Contents: 1 keeper; installation fasteners.

Description: **Zinc plated steel**; acts to reinforce the latch hole on the door jamb; fits on *Adams Rite*.

You may wish to stock these related parts: **C-1023, E-2008, E-2009, E-2013, E-2014**.

E-2101

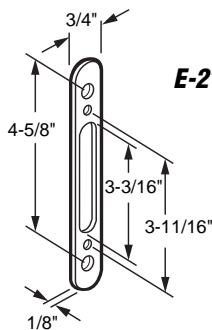

E-2101

Trim Plate

Contents: 1 trim plate; 1 fastener set.

Description: **Zinc plated steel** trim plate for adapting **E-2009** and **E-2013** mortise locks to wood door stiles.

You may wish to stock these related parts: **E-2008, E-2009, E-2011, E-2013, E-2014**.

E-2015

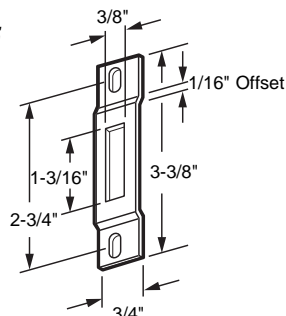

E-2015

Keeper

Contents: 1 keeper; installation fasteners.

Description: Surface mount; for hook style latch; **zinc plated steel**; fits on *W&F* and other manufacturers.

You may wish to stock these related parts: **E-2013, E-2014**.

E-2085

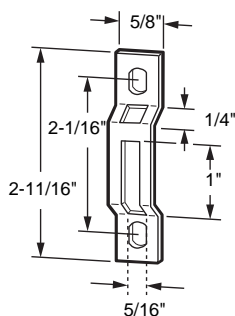

E-2085

Keeper

Contents: 2 keepers; installation fasteners.

Description: **Stamped steel** keeper; narrow style design.

You may wish to stock these related parts: **C-1016; C-1023-24; C-1048; E-2008; E-2009; E-2013-14**.

E-2136

Keeper

Contents: 1 keeper; installation fasteners.

Description: 1 stamped aluminum strike; fits on *Premier* series 210 doors.

E-2136

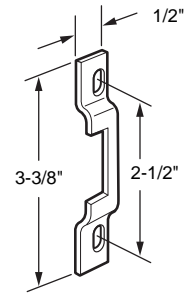

E-2018

Keeper

Contents: 1 keeper; installation fasteners.

Description: Surface mount; for hook style latch; zinc plated steel. Used by *W&F*.

Call for Availability

E-2018

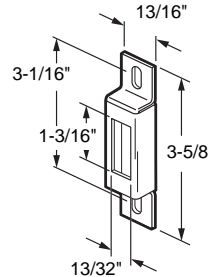

E-2124 (White)

Keeper

Contents: 1 keeper; installation fasteners.

Description: Extruded aluminum; surface mount; for hook style latch; fits on *Viking*.

E-2124

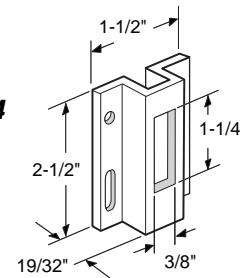

E-2050 (Aluminum)

E-2051 (Black)

Keeper

Contents: 1 adjustable latch strike; installation fasteners.

Description: Extruded aluminum strike has projection adjustment; fits on *Pacific* and other manufacturers.

You may wish to stock these related parts: **C-1000, C-1016, C-1020, C-1079.**

**E-2050
E-2051**

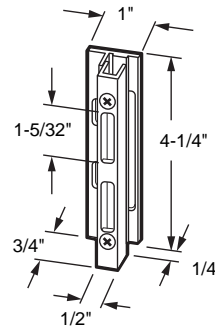

E-2061 (Black)

E-2150 (White)

Keeper

Contents: 1 keeper; installation fasteners.

Description: Side mount; plastic keeper with metal insert; special fastener package to attach keeper to jamb.

You may wish to stock these related parts: **C-1000, C-1060, C-1070, E-2078.**

**E-2061
E-2150**

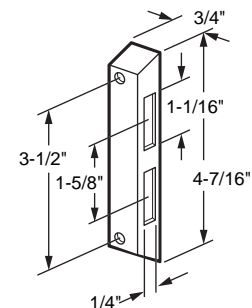

E-2078 (Black)

E-2160 (White)

Keeper

Contents: 1 keeper; installation fasteners.

Description: Face mount; plastic keeper with metal insert.

You may wish to stock these related parts: **C-1000, C-1001, C-1060, C-1070, E-2061.**

**E-2078
E-2160**

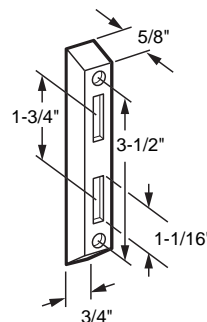

E-2125

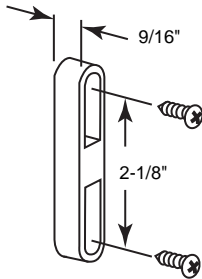
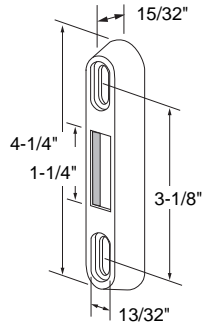

E-2134

**E-2052
E-2053**

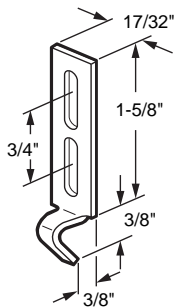
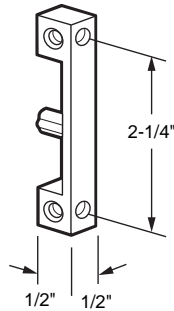

E-2054

E-2122

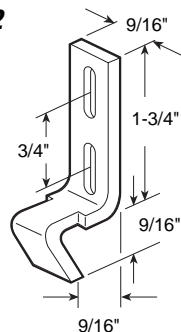

E-2125 Keeper

Contents: 1 keeper; installation fasteners.

Description: Diecast keeper; fits on *W&F*.

E-2134 Keeper

Contents: 1 keeper; installation fasteners.

Description: Zinc plated diecast adjustable keeper for mortise lock E-2079.

E-2052 (Aluminum) E-2053 (Black) Keeper

Contents: 1 keeper; installation fasteners.

Description: Heavy-duty diecast keeper; can be used for face or side mount.

You may wish to stock these related parts: **A-103, C-1016**.

E-2054 Keeper

Contents: 2 keepers; installation fasteners.

Description: Stamped steel keeper; screw slots allow for vertical adjustment.

You may wish to stock these related parts: **C-1018, C-1095**.

E-2122 Keeper

Contents: 2 keepers; installation fasteners.

Description: Stamped steel keeper; screw slots allow for vertical adjustment.

You may wish to stock these related parts: **E-2054**.

Sliding Patio Door

E-2086

Keeper

Contents: 2 keepers; installation fasteners.

Description: Stamped steel keeper; fits on *Daryl* and *Crossly*.

E-2028

Keeper

Contents: 1 keeper; installation fasteners.

Description: Stamped steel keeper; designed to work with mortise lock *E-2027*; fits on *Daryl Doors*.

You may wish to stock these related parts: *C-1035*, *C-1036*, *E-2027*.

E-2144 (White)

Keyed Locking Unit

Contents: 1 lock housing; 1 cylinder lock with 2 keys; installation fasteners.

Description: Diecast housing used to convert *C-1177* to keyed locking handle

E-2145 (White)

E-2146 (Brass)

Keyed Locking Unit

Contents: 1 lock housing; 1 cylinder lock with 2 keys; installation fasteners.

Description: Diecast housing: used to convert *C-1174*, *C-1176* & *C-1178* to keyed locking handle.

E-2007

Keyed Locking Unit

Contents: 1 lock housing; 1 lock activator yoke; 1 lock base; 1 cylinder lock with 2 keys; installation fasteners.

Description: Zinc diecast lock housing with activator yoke; plastic base; fits on *Guaranteed Products* to key lock *C-1028* handle set.

You may wish to stock these related parts: *C-1028*, *E-2000*, *E-2080*, *E-2109*.

E-2086

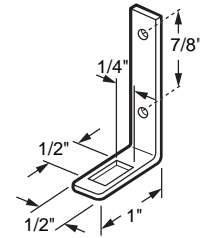

E-2028

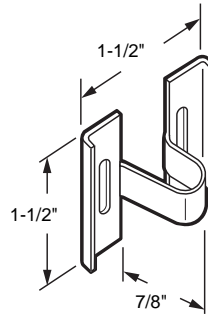

E-2144

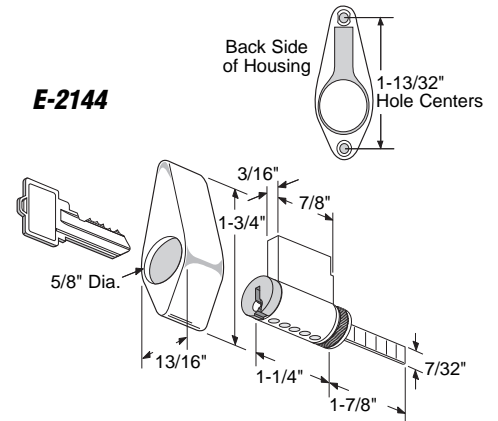

E-2145 E-2146

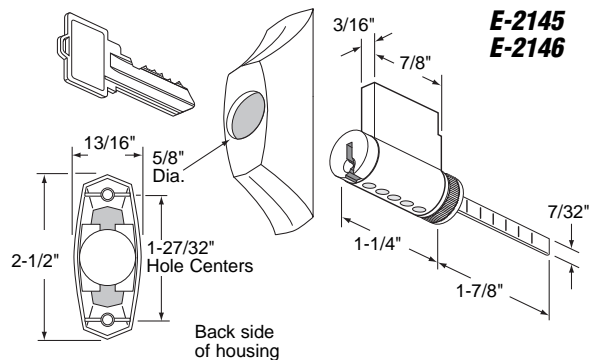

E-2007

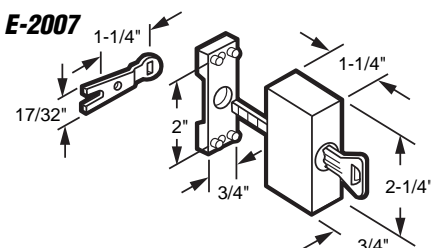

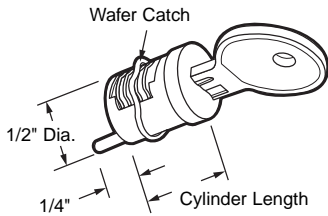

E-2005 (cylinder length - 13/16")
E-2087 (cylinder length - 7/8")
E-2088 (cylinder length - 1-1/4")

E-2115

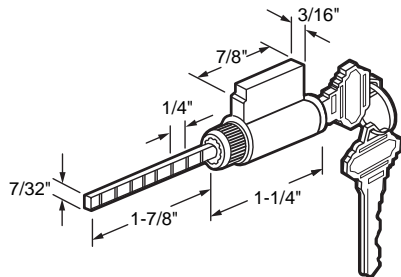
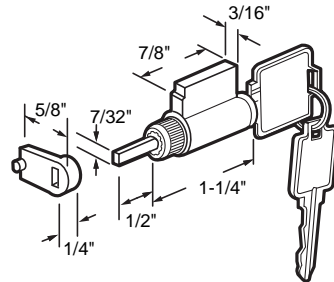

E-2103
E-2104

E-2000
E-2107

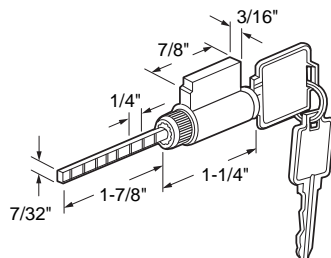

E-2003

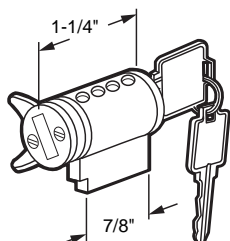

E-2005 (1" thick door)*
E-2087 (1-1/8" to 1-1/4" thick door)
E-2088 (1-1/2" thick door)

Cylinder Lock

Contents: 1 lock with 2 keys.

Description: Wafer type; **diecast** housing; used to keylock most flush mount handle sets.

*This lock is also available **keyed alike**, in bulk, with a maximum 25 units per KA number available.

You may wish to stock these related parts: **C-1032, C-1033, C-1045, C-1075, C-1076.**

E-2115 (with adapter)

Cylinder Lock

Contents: 1 lock with 2 keys; 1 lock activator.

Description: 5 pin tumbler lock; **solid brass** housing; keyway is compatible with **Weiser, Kwikset** and **Weslock**; special diecast cam adapter; used by various manufacturers.

E-2103

E-2104 (Keyed alike)

Cylinder Lock

Contents: 1 lock with 2 keys.

Description: 5 pin tumbler lock; hardened break-away tailpiece; **Schlage** keyway; used to keylock most surface mount handle sets.

You may also wish to stock these related parts: **E-2000, E-2104, E-2107.**

E-2000

E-2107 (Keyed alike)

Cylinder Lock

Contents: 1 lock with 2 keys.

Description: 5 pin tumbler lock with 2 keys; hardened break-away tailpiece; keyway is compatible to **Weiser, Kwikset & Weslock**; used to keylock most surface mount handle sets.

You may also wish to stock these related parts: **C-1056, E-2001, E-2002, E-2070.**

E-2003

Cylinder Lock

Contents: 1 lock with 2 keys.

Description: 5-pin tumbler style lock with **diecast** latch activator; used to keylock **C-1025** handle; keyway is compatible to **Weiser, Kwikset & Weslock.**

You may wish to stock these related parts: **E-2000, E-2004, E-2103.**

Call for
Availability

E-2006

Cylinder Lock

Contents: 1 lock; 1 plastic housing; 2 keys.

Description: Wafer type; flat activator link 1/2" long; fits on *Wright Products*.

E-2006

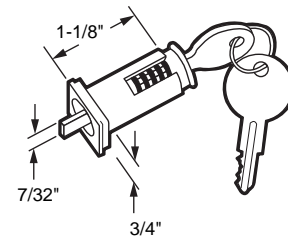

E-2090

Cylinder Lock

Contents: 1 lock; 2 keys.

Description: Key locking unit with flat tab; diecast construction; wafer type; fits on *Wright Products*.

E-2090

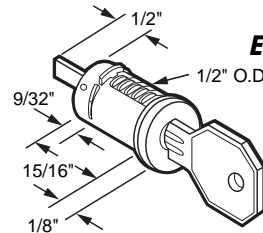

E-2110

Cylinder Lock

Contents: 1 lock; 2 keys.

Description: Key lock used on C-1074 handle; includes plastic activator tip.

You may wish to stock these related parts: C-1074, C-1099.

E-2110

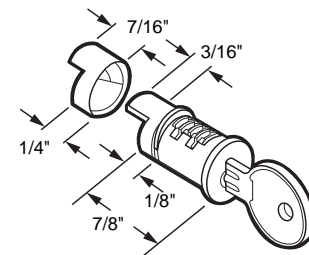

E-2140 (Brushed chrome)

Cylinder Lock

Contents: 1 lock; 2 keys and installation fasteners.

Description: Solid brass double cylinder key lock, 5 pin tumbler used on multi-thickness security doors.

Call for Availability

E-2140

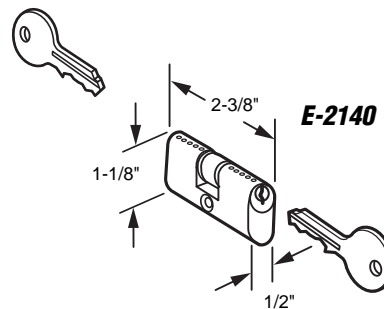

E-2070 (Aluminum)

E-2071 (Black)

Keyed Locking Pull

Contents: 1 outside pull; 1 locking cylinder; 1 cylinder clip.

Description: Extruded aluminum flush outside pull with keyed locking unit; locking unit tailpiece with break-off points; used by many manufacturers for 4-15/16" hole center installations.

You may wish to stock these related parts: E-2000, E-2001.

**E-2070
E-2071**

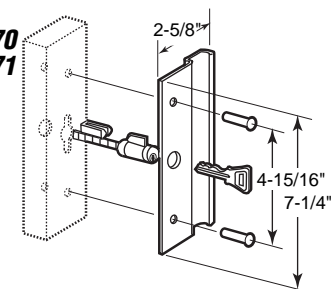

E-2072 (Aluminum)

E-2073 (Black)

Keyed Locking Pull

Contents: 1 outside pull; 1 locking cylinder; 1 cylinder clip.

Description: Extruded aluminum flush outside pull with keyed locking unit; locking unit tailpiece with break-off points; used by many manufacturers for 3" hole center installations.

You may wish to stock these related parts: C-1022, C-1072, C-1073, E-2000.

**E-2072
E-2073**

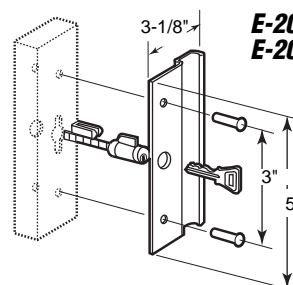

E-2095
E-2139
E-2117

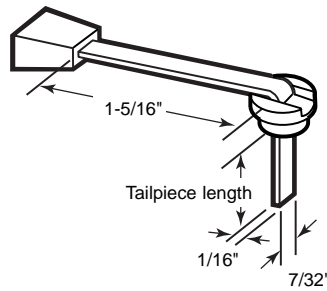

E-2095 (3/4" long tailpiece)
E-2139 (1" long tailpiece)
E-2117 (1-3/8" long tailpiece)

Latch Lever

Contents: 1 latch lever with plastic bushing.

Description: Steel latch lever with plastic thumb button.

You may wish to stock these related parts: **C-1019, C-1058, E-2000, E-2008, E-2009, E-2013, E-2014.**

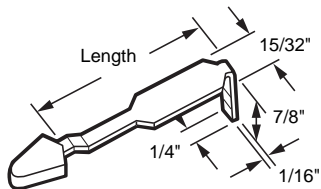

E-2066
E-2113

E-2066 (1-3/4")
E-2113 (2")

Latch Lever

Contents: 1 latch lever.

Description: Stamped steel lever with black plastic tip; fits on *Adams Rite*.

You may wish to stock these related parts: **E-2008, E-2009.**

E-2038

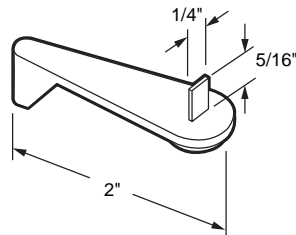

E-2038 (Black)

Latch Lever

Contents: 1 latch lever.

Description: Plastic with steel pin; fits on *Marshall* and others.

Call for
Availability

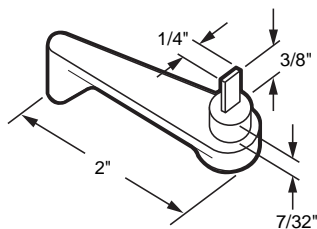

E-2037

E-2037 (Gray)

Latch Lever

Contents: 1 latch lever.

Description: Plastic with steel pin; fits on *Arcadia* and other manufacturers.

E-2065

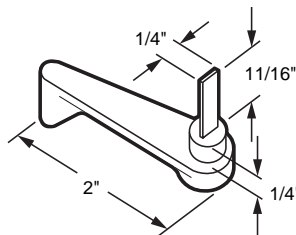

E-2065 (Gray)

Latch Lever

Contents: 1 latch lever.

Description: Plastic with steel pin; used by several manufacturers.

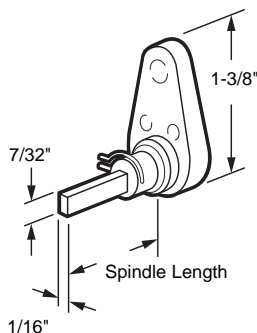

E-2035
E-2112

E-2035 (1" long spindle)
E-2112 (1-1/2" long spindle)

Latch Lever (Gray)

Contents: 1 lever, washer, spring washer and pin.

Description: Diecast latch lever with steel pin; fits on *Fleetwood* and other manufacturers.

You may wish to stock these related parts: **C-1035, C-1036, C-1039.**

E-2036

Latch Lever

Contents: 1 latch lever.

Description: Diecast with steel pin; fits on *Arcadia*.

Call for
Availability

E-2033

Latch Lever and Escutcheon Plate

Contents: 1 thumbturn and plate.

Description: Aluminum plate; diecast thumbturn with steel pin; used by many manufacturers

You may wish to stock these related parts: C-1035, E-2008, E-2009, E-2012, E-2013, E-2014, E-2112.

E-2034

Latch Lever and Escutcheon Plate

Contents: 1 latch lever; 1 plate, installation fasteners.

Description: Diecast lever with steel pin and aluminum plate; repair part for sliding patio door handles; fits on *Hollyview* and other manufacturers, popular part for C-1039.

You may wish to stock these related parts: C-1035, C-1036, E-2008, E-2009, E-2012, E-2013, E-2035, E-2112.

E-2147 (White)

Thumbturn and Escutcheon Plate

Contents: 1 thumbturn & plate; installation fasteners.

Description: Diecast thumbturn and plate, tail piece is 1-1/16" long and turned 45° from thumbturn.

You may wish to stock these related parts: E-2014, E-2079, E-2126.

E-2039

Latch Lever

Contents: 1 latch lever and rivet.

Description: Plastic lever; fits on *International* handle sets C-1022, C-1055, C-1072, C-1073.

E-2062

Latch Lever

Contents: 1 latch lever, 1 machine screw.

Description: Diecast lever; repair part for *Fullview* handle set C-1023.

You may wish to stock these related parts: A-103, C-1023.

E-2036

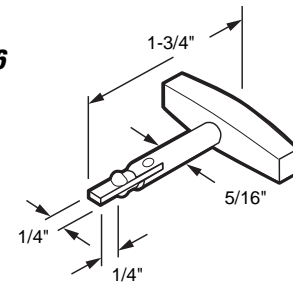

E-2033

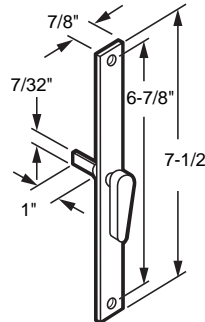

E-2034

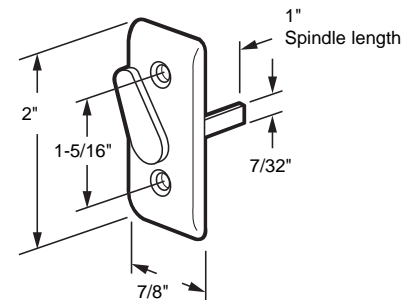

E-2147

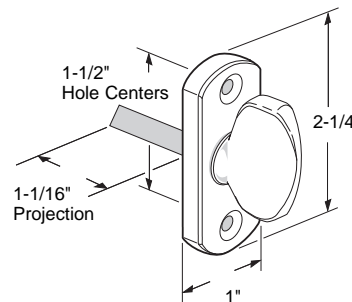

E-2039

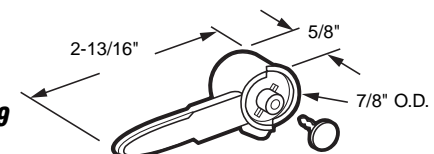

E-2062

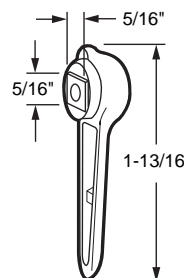

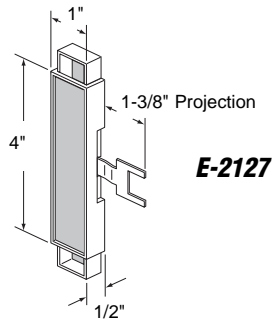

E-2127

E-2127 (Black)

Slide Latch Assembly

Contents: 1 latch assembly; installation fasteners.

Description: Plastic housing with stamped steel activator fork; replacement latch for **C-1028** handle set, fits on *Guaranteed Products*.

You may wish to stock these related parts: **C-1028, D-1547, E-2080, E-2109.**

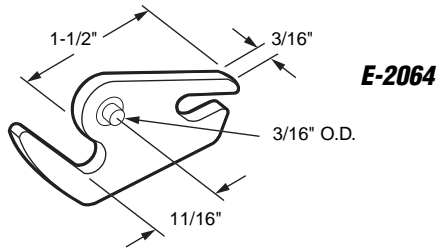

E-2064

E-2064

Latch Hook

Contents: 1 latch hook.

Description: Diecast hook; repair part for *Horizon* door handle set **C-1046**.

Call for
Availability

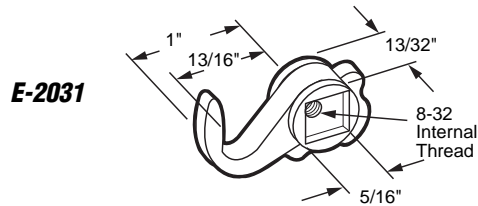

E-2031

E-2031

Latch Hook

Contents: 2 hooks; 2 springs; installation fasteners.

Description: Diecast hook; repair part for old style *Fullview* surface mounted handle sets, **C-1023 & C-1024**.

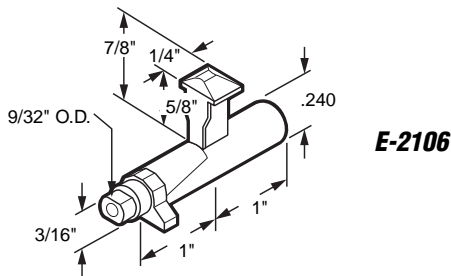

E-2106

E-2106

Latch Hook

Contents: 1 hook.

Description: Diecast hook for 1-1/4" thick doors; as used on **C-1018 & C-1095** handle sets.

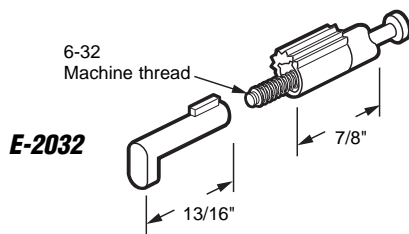

E-2032

E-2032

Latch Pins

Contents: 2 spring loaded latching assemblies.

Description: Plastic sleeves with steel inserts; locking pins fits on *Ador/HiLite* on **C-1014 & C-1015** handle sets.

You may wish to stock these related parts: **C-1010, C-1012, C-1014, C-1015, E-2092.**

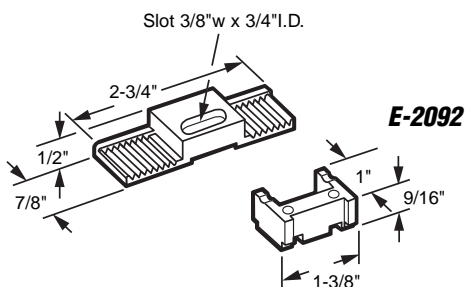

E-2092

E-2092

Latch Repair Kit

Contents: 1 center gear slide; 2 end caps.

Description: Plastic component parts for *Adore/HiLite* locking mechanism on handle sets **C-1014 & C-1015**.

You may wish to stock these related parts: **C-1014, C-1015, E-2032.**

Sliding Patio Door

E-2075 (Left hand)

E-2081 (Right hand)

Latch Hook

Contents: 1 hook; 1 special binder post; 1 Phillips head machine screw.

Description: Diecast hook; repair part for *Trimview* patio door lock; specify left hand or right hand, viewing from inside.

E-2067

Latch Lever

Contents: 1 latch lever.

Description: Diecast latch; fits on *Trimview* handle set **C-1025**.

You may also wish to stock these related parts: **C-1025**, **E-2068**, **E-2076**.

E-2068

Latch Yoke

Contents: 1 yoke.

Description: Diecast yoke; fits on *Trimview* handle set **C-1025**.

You may wish to stock these related parts: **C-1025**, **E-2067**, **E-2076**.

E-2076

Latch Spring

Contents: 2 springs.

Description: Steel latch spring; fits on *Trimview*; repair part for **C-1025** handle set.

You may wish to stock these related parts: **C-1025**, **E-2067**, **E-2068**.

E-2108

Hook Set

Contents: 4 Hooks.

Description: Stamped steel hooks for flush style lock assemblies; 4 projections; universal design.

You may also wish to stock these related parts: **C-1032**, **C-1034**, **C-1045**, **C-1075**.

E-2004

Lock Adapter

Contents: 1 adapter.

Description: Diecast adapter; used as lock activator on **E-2003** locking cylinder.

You may wish to stock these related parts: **E-2003**, **C-1025**, **E-2068**, **E-2067**.

E-2075
E-2081

Left hand shown

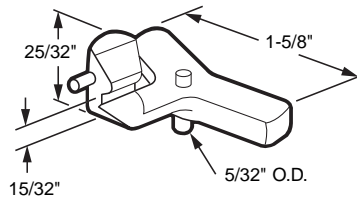
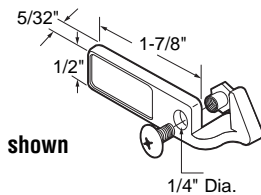

E-2067

E-2068

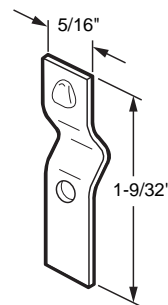
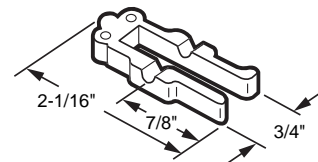

E-2076

E-2108

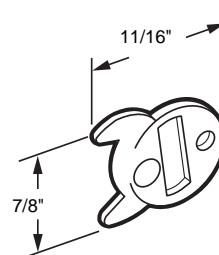
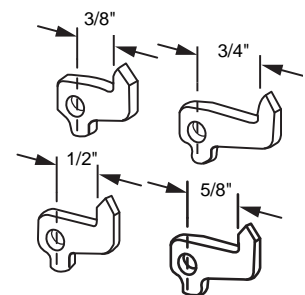

E-2004

E-2002

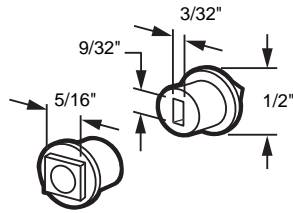

E-2002

Locking Cylinder Adapter

Contents: 1 adapter.

Description: Diecast adapter; provides connection between cylinder lock and latch assembly used with **C-1023** handle set.

You may wish to stock these related parts: **C-1049, C-1073, E-2000.**

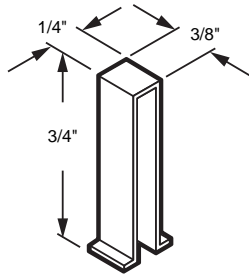

E-2001

E-2001

Lock Clip

Contents: 1 clip.

Description: Lock retainer clip; **spring steel**; holds cylinder in place on many doors.

You may wish to stock these related parts: **E-2000, E-2070 thru E-2073.**

E-2102

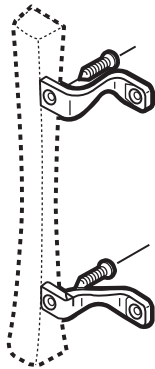

E-2102

Handle Brackets

Contents: 1 left hand and 1 right hand bracket; 1 fastener set.

Description: Diecast **chrome plated** bracket set for attaching wood handles.

You may wish to stock these related parts: **C-1032, C-1034.**

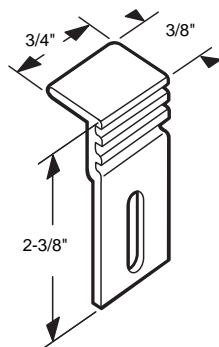

E-2132
E-2133

E-2132 (Aluminum)

E-2133 (Bronze)

Panel Clip

Contents: 4 Clips and installation screws.

Description: Used to secure stationary panel on **Ador /HiLite** series 1200 patio door.

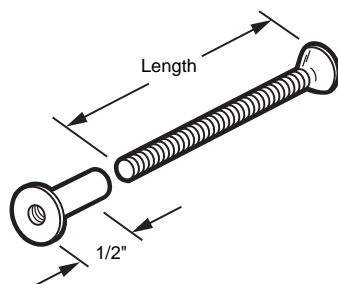

E-2056 (1" Aluminum)

E-2057 (1-1/4" Aluminum)

E-2155 (1-1/2" Aluminum)

E-2055 (2" Aluminum)

E-2152 (2-1/4" Aluminum)

E-2059 (1" Black)

E-2060 (1-1/4" Black)

E-2156 (1-1/2" Black)

E-2058 (2" Black)

E-2153 (2-1/4" Black)



Binder Posts and Fasteners

Contents: (4) 1/2" binder posts; 4 Phillips flat head machine screws.

Description: Used for attaching handle sets to sliding patio doors and sliding screen doors; check part numbers for screw length.